



## 1. Safety warnings

This instrument has been designed, manufactured and tested according to IEC61010-1:2001, IEC 61557-1:1997 safety requirements. This instruction manual contains warnings and safety rules which must be observed by the user to ensure safe operation of the instrument and retain it in safe condition. Therefore, read through these operating instructions before using the instrument.

The symbol  indicated on the instrument means that the user must refer to related parts in the manual for safe operation of the instrument. Be sure to carefully read the instructions following each  symbol in the manual.

### **DANGER**

**is reserved for conditions and actions that are likely to cause serious or fatal injury.**

### **WARNING**

**is reserved for conditions and actions that can cause serious or fatal injury.**

### **CAUTION**

**is reserved for conditions and actions that can cause injury or instrument damage.**

### **WARNING**

- **Read through and understand instructions contained in this manual before starting to use the instrument.**
- **Save and keep the manual an hand to enable quick reference whenever necessary.**

- **Wrong operation may cause injury, instrument damage and/or damage to equipment under test.**

 **DANGER**

- **Never make measurement on the circuit in which electrical potential to ground over DC1000V exists.**
- **Do not attempt to make measurement in the presence of flammable gasses. Otherwise, the use of the instrument may cause sparking, which can lead to an explosion.**
- **Never attempt to use the instrument if its surface or your hand is wet.**
- **Be careful not to short-circuit the power line with the metal part of the test leads when measuring voltage. It may cause personal injury.**
- **Do not exceed the maximum allowable input of any measuring range.**
- **Do not press the PRESS TO TEST button when short-circuit test line connected to the instrument.**
- **Never open the battery compartment cover while making measurement.**
- **Do not touch the circuit under test when measuring insulation resistance or right after a measurement. You may get an electric shock by a test voltage.**

 **WARNING**

- **Never attempt to make any measurement if any abnormal conditions are noted, such as broke case and exposed metal parts.**

- **Inspect the test leads and power adapter for damaged. Replace damaged test leads and power adapter.**
- **Do not rotate switch with the test leads connected to the equipment under test.**
- **Use caution when working above 30 V ac rms, 42 V peak, or 60 V dc. Such voltages pose a shock hazard.**
- **Avoid working alone.**
- **After measuring the insulation resistance the stored charge of the test circuit must be released.**
- **Do not try to replace the batteries if the surface of the instrument is wet.**
- **Be sure to insert the plug into the terminal firmly when using test leads.**
- **Make sure to power off the instrument when opening the battery compartment cover for battery replacement.**







#### **CAUTION**

- **Always make sure to set the range switch to the appropriate position before making measurement.**
- **Be sure to set the range selector switch to “OFF” position after use and remove test leads. When the instrument will not be in use for a long period, place it in storage after removing the batteries.**
- **Do not use the instrument when battery mark is vacant .**

- The circuit must be fully discharged, and with the complete separation of power circuit before in the measurement of resistance.
- Do not expose the instrument to high temperature, high humidity, flammability, explosive and strong electromagnetic field.
- Use a cloth dipped in water or neutral detergent for cleaning the instrument. Do not use abrasives or solvents.
- When this instrument is wet, please store it after it dries.

## Symbols

	Danger of possible electric shock
	Instrument with double insulation
	DC
	AC
	Earth terminal

## **2. This manual applies to models**

The manual applies to 2500V and 5000V-type instrument. Manual all the explanations and examples for illustration is based on 5000V-type.

## **3. Feature**

The instrument is an intelligence micro-machines, that is say the one is the insulation test instrument with its circuitry design using the technology at the core, combination of large scale integrated circuit (LSI) and digital circuit, matching powerful measure software, completing parameter measurement such as insulate electric resistance and electric tension and so, tester steady performance, easy and simple handle. It is the ideal choice for the users who work on measuring and amending on on-site power equipment and power supply circuit.

- This instrument has been designed, manufactured according to IEC 61010:2001. Designed to following safety standards:
  - IEC 61010-1(CAT.III 600V Pollution degree 2)
  - IEC 61557-1:1997
  - IEC 61557-2:1997
- With auto-discharge function
- USB interface data transmission
- White backlight function to facilitate working at dimly illuminated location
- Bar graph to display measured result
- With special-purpose power source adapter

- High-voltage prompt
- The actual output voltage value is displayed on the second secondary display. At the same time, the measured value of insulation resistance is displayed on primary display.
- Temperature , 24-hour time and leakage current display
- With Auto-power off function  
The meter will go into automatic power-off mode if you have not changed the rotary switch position or pressed a button for a set period. Set range 0~60 min. Set zero to cancel auto power-off function.To turn the meter on after automatic power-off of the meter, please set the function range switch to “OFF” position, and then set the function range switch to any position other than “OFF”.
- Independent of internal memory can store up to 1500 (group) measurements. (manual records 500 (group), the operating records 1000 (group))
- With Timer measurement function  
Automatically performs a measurement at the set time.
- With Polarization index measurement  
The polarization index can be measured by the automatic measurement function of the ratio of resistance in arbitrary two point time.
- With Dielectric Absorption Ratio measurement  
The Dielectric Absorption Ratio can be measured by the automatic measurement function of the ratio of resistance in arbitrary two point time.
- With Step Voltage measurement

Raising the voltage at a certain period and measuring the insulation resistance.

- RAMP measurement (ramp voltage measurement)

The voltage is made to rise over a certain period of time and the insulation resistance of each voltage segment is measured.

- Fault Mode

When a sharp drop in applied voltage due to insulation deterioration such as a fault or sudden current rise is detected, the test is terminated at the point of time where the sharp drop is detected to avoid more serious damage, and the test continues if no fault or sudden current rise is detected.

This mode is an accompanying function to the RAMP measurement.

- Comparative mode

When the insulation resistance measurement result is compared with the set resistance limit, if the result is greater than the set limit, the LCD displays the character of PASS; if it is less than the set limit, the LCD displays the character of FALL.

See Chapter 9.1 of this Manual for settings of resistance limit.

This mode is an accompanying function to insulation resistance measurement.

- Built-in real-time clock can provide accurate time for recording and measuring.

- Panel calibration technology, no need to open the chassis can be calibrated.

## 4. Specification

- Applicable standards

IEC 61010-1: 2001 Measurement CAT.III 600V Pollution degree2

Measurement CAT.I 5000V Pollution degree2

IEC 61010-2-031 Standard for hand-held probes

IEC61557-1: 1997

IEC61557-2: 1997

IEC 60529 IP40

- Measuring range and accuracy

Accuracy specifications are given as:  $\pm$  ( [% of reading ]+[number of least significant digits]). Year guarantee period. (“Counts” refers to the number of increments or decrements of the least significant digit)

Temperature:  $23 \pm 5^{\circ}\text{C}$

Humidity: 45~75%RH



<Insulation resistance tester>

Rated voltage	250V	500V	1000V	2500V	5000V
Measuring Range	0.0~99.9MΩ 100~999MΩ 1.00~9.99GΩ 10.0~99.9GΩ 100~250GΩ	0.0~99.9MΩ 100~999MΩ 1.00~9.99GΩ 10.0~99.9GΩ 100~500GΩ	0.0~ 99.9MΩ 100~999MΩ 1.00~9.99GΩ 10.0~99.9GΩ 100~1000GΩ	0.0~99.9MΩ 100~999MΩ 1.00~9.99GΩ 10.0~99.9GΩ 100~1000GΩ 1.00~2.50TΩ	0.0~99.9MΩ 100~999MΩ 1.00~9.99GΩ 10.0~99.9GΩ 100~1000GΩ 1.00~10.00TΩ
Open circuit Voltage	DC 250V + 20% , -0%	DC 500V + 20% , -0%	DC 1000V + 10% , -0%	DC 2500V + 10% , -0%	DC 5000V +10% , -0%
Drop resistance	0.23MΩ	0.45MΩ	1MΩ	2.5MΩ	5MΩ
Short-circuit Current	Approx 3mA				
Accuracy	5% +3 / ±20% (100GΩ or more)				

- Automatic discharge time of insulation test: capacitance  $C = 1 \mu F$  or less, discharge time  $< 1$  second.
- Insulation test live circuit detection: before the test initialization, if the terminal voltage is greater than 30 V, the alarm forbids the test.
- Insulation test maximum capacitive load:  $1 \mu It$  can be operated below.

Voltage monitor for insulation resistance range

0~5000V (resolution 1V): 2% rdg +3 dgt

This monitor is used to check whether electric charge stored on the equipment under test is discharged or not. Measured voltage value displayed on the LCD is a reference value. Please be noted that the indicated value, when external AC Voltage is applied to the instrument is not the correct value.

<Leakage current tester>

Current range	Measuring range	Accuracy
0.5nA	0.000~0.500nA	3% +5
5nA	0.500~5.000nA	3%+5
50nA	5.00~50.00nA	2%+5
500nA	50.0~500.0nA	2%+5
5uA	0.500~5.000uA	2%+5

50uA	5.00~50.00uA	2%+5
500uA	50.0~500.0uA	2%+5
5000uA	500~5000uA	2%+5

#### <Voltmeter>

	DC voltage	AC voltage
Measuring range	0~±1000V	30~750V (50/60Hz)
Resolution	1V	
Accuracy	2%+3	

#### <Temperature tester>

This instrument can measure the temperature of the environment, and can display the temperature by °C or °F.

- Display: Liquid crystal display (Max. 999 counts)(120 counts only at 1 TΩ is displayed)  
Voltage range: Max. 6000 counts  
Bar graph / Max. 36 points

- Sample rate: approx. 0.5 ~ 5 times/sec.  
Temperature measurement rate: 1 times/5 sec.
- Low battery warning: Battery mark display ( in 4 levels )
- Overrange indication :“OL” mark appears on insulation resistance range.
- Auto-ranging function
- Units display: including function and power symbolic
- Operable altitude: 2000m or less above sea level
- Temperature & humidity range ( guaranteed accuracy):  
23°C±5°C / Relative humidity 75% or less ( no condensation)
- Operating temperature & humidity range:  
5°C~40°C / Relative humidity 75% or less ( no condensation)
- Storage temperature & humidity range:  
-10°C~55°C / Relative humidity 75% or less ( no condensation)
- Overload protection:  
Insulation resistance function: AC1200V/10sec  
Voltage function: AC720V/10sec
- Withstand voltage: AC8320V(50/60Hz)/5sec (Between electrical circuit and enclosure)
- Insulation resistance: 1000MΩ or more/ DC 1000V (Between electrical circuit and enclosure)
- Dimension: 210 (L) × 155 (W) × 95 (D)mm

- Weight: approx. 1750g (Barring battery)
- Current consumption: approx. 1.2A(Max)( Normally maintained at approx. 120mA)

Range	250V	500V	1000V	2500V	5000V	V
Output at short-circuit	1000mA	950mA	800mA	700mA	600mA	120mA (电压测量时)
When rated current is outputted	450mA 0.23MΩ	500mA 0.45MΩ	500mA 1MΩ	670mA 2.5MΩ	750mA 5MΩ	
Output at open circuit	45mA	50mA	60mA	90mA	140mA	
On stand-by	20mA	20mA	20mA	20mA	20mA	120mA
When backlight is on	增加 150mA					

- Measurement time: approx. for 8hours  
Representative value till battery voltage of 9.0V  
Applying a load of 100 M $\Omega$  on the insulation resistance 5000V range.
- Accessories: A set of test leads: G000031B,G000031G,G000032  
Alkaline size C battery 1.5V(LR6) ×8pcs  
Power adapter: P070000-00  
Interface software disk: EIRM-CD  
USB Interface cable  
User manual: E100034E  
Hard Case: C440008

## 5. Instrument layout

### 5.1 Instrument elevation ( As shown in Figure 1 )

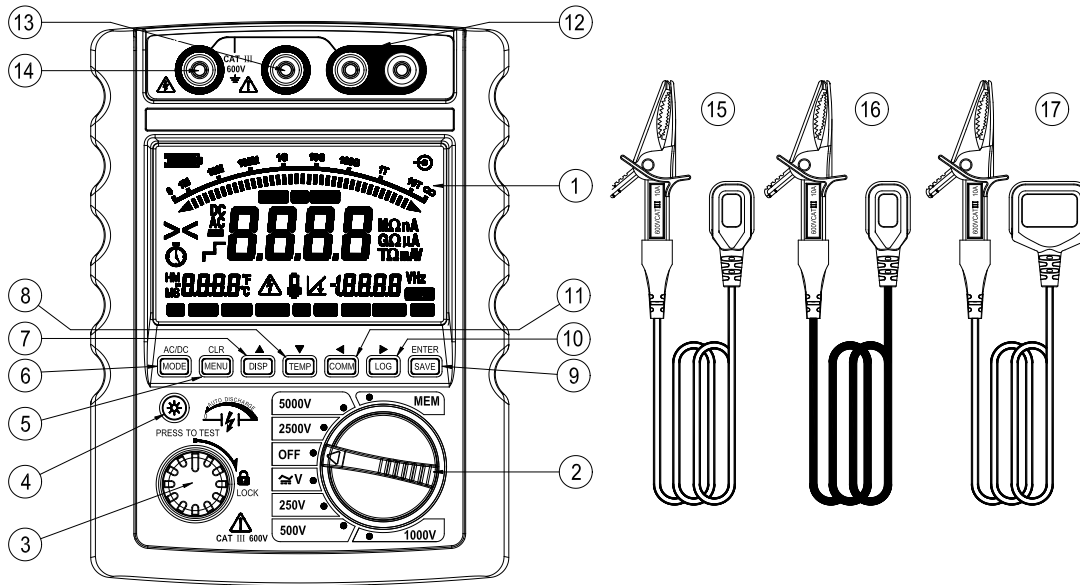

Figure 1

No.	Funtion	No.	Funtion
①	LCD display	②	Range Switch
③	PRESS TO TEST button	④	Back Light button
⑤	Maintenance / Clearing Data button	⑥	Function Selection / (AC/DC)Switch button
⑦	Leakage current / Upper(▲) button	⑧	Temperature / Lower(▼) button
⑨	SAVE / Enter button	⑩	LOGG / Right Shift (►) button
⑪	Communication Enabling / Left shift button (◄) button	⑫	EARTH: Earth Terminal
⑬	GUARD: Guard Terminal	⑭	LINE : High-voltage Terminal
⑮	Guard Cord (green)	⑯	High Voltage Cord (Red)
⑰	Guard Cord (BLACK) Special dual-plug Cord		

**5.2 Instrument side elevation ( As shown in Figure 2)**

**5.3 LCD display (As shown in Figure 3)**



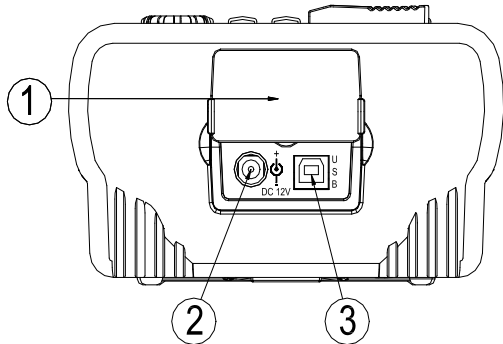

Figure 2

No.	Name
①	Sliding Door
②	Power adapter jack
③	USB Communication interface

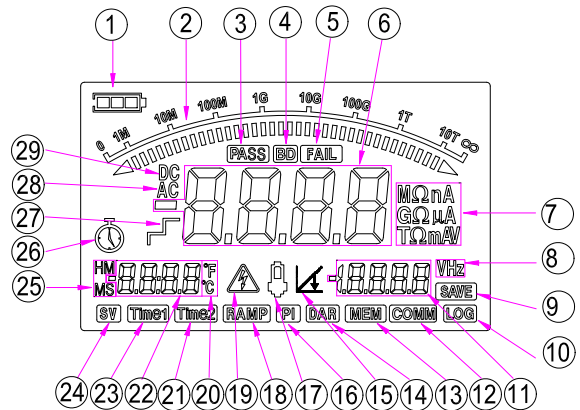

Figure 3

<b>Display symbols</b>	<b>Function Description</b>
①	Battery mark
②	Bar graph
③	Prompt for Passing the Comparison Functional Test
④	Prompt for Fault Mode of Insulation Test
⑤	Prompt for Failure to Pass the Comparison Functional Test
⑥	Primary Display
⑦	Primary Display Unit
⑧	Second Secondary Display Unit
⑨	Manual stored mode
⑩	Log stored mode
⑪	Second Secondary Display
⑫	Prompt for Communication Enabling
⑬	Readings are being recorded in manual stored mode

⑭	DAR mark
⑮	Information Sign for Occurrence of Insulation Test Failure Mode
⑯	PI mark
⑰	Information Sign for Instrument Overheating
⑱	Sign for Automatic Insulation Ramp Measurement Mode
⑲	High Voltage mark
⑳	Temperature Unit
㉑	TIME2 mark
㉒	First secondary display
㉓	TIME1 mark
㉔	SV mark
25	Elapsed Time Display ( hour : min / min : sec )
26	Timer display
27	Sign for Automatic Insulation Ramp/Stepping Measurement Mode

28	AC
29	DC

## 6. Preparation for measurement

### 6.1 Turning the Meter On

To turn the meter on, please set the function range switch to any position other than “OFF”.

To turn the meter off, please set the function range switch to “OFF” position.

When the power is turned on, the meter starts to make self-diagnosis internally and display 50Hz ( or 60Hz, see Chapter 9 (“Changing the Default Settings”) and current time. After this, appropriate operation should be carried out.



#### **CAUTION**



**Power-on :** To ensure the correct operation of the meter with power on. It is good practice to turn off the power supply pausing 5 seconds, and then restart the meter.

### 6.2 Automatic Power Off

The meter will go into automatic power- off mode if you have not changed the rotary switch position or pressed a button for a set period. The automatic power off is preset to 10 minutes.

From the Setup menu (see Chapter 9 “Changing the Default Settings”), users can decide whether they want to use the function of the automatic power-off or not.

### 6.3 Backlight function

To turn the backlight on, press  to turn on and press  again to turn off.



### 6.4 Automatic backlight off





The automatic backlight off is preset to 10s. If user does not turn off backlight within 10s, the meter will turn off backlight automatically.

From the Setup menu( see Chapter 9 “Changing the Default Settings”), users can decide whether they want to use the function of the automatic backlight off or not.

### 6.5 Checking the battery voltage

(1) Set the function range switch to any position other than “OFF”.

(2) When the battery mark shown at the upper left on the LCD is last 1 level  , the battery is almost exhausted. Replace the batteries to proceed to measurement. The instrument operates properly even if under such a low battery, and it may not affect on the accuracy. When battery mark is vacant  , the battery voltage is below the lower limit of the operating voltage. So the accuracy cannot be guaranteed. The relation between battery symbol and battery voltage is explained in following table:

display	Battery voltage
	8.5V or less
	8.6~9.0V
	9.1~10.2V
	10.3V or more

## 6.6 Connecting test leads

Insert the test lead firmly to the connector terminal on the instrument. Connect Line Probe(red) to Line terminal, Guard Cord(green) to Guard terminal, Earth Cord(black) to Earth terminal.

### DANGER

If “PREDD TO TEST” button is pressed when the range switch is at the insulation measurement position, high voltage may applied on the test lead and you may get an electric shock.

## 7. Measurement

### CAUTION

**Before measuring, please set the function range switch to compatible position, and set the corresponding test line to the circuit.**

**Forbid to switch the range switch during the measuring process. Online communication is not allowed during the measuring process.**

## 7.1 Voltage measurement ( As shown in Figure 4)



### **DANGER**

- **Do not make measurement on a circuit above AC/DC 600V/1000V ( voltage to earth ) to avoid possible electric shock. Do not make a measurement, even if the line voltage is 600V/1000V or less, when a voltage to earth is over 600V/1000V.**
- **When testing installation that has a large current capacity, such as a power line, be sure to make measurement on the secondary side of a circuit breaker in order to avoid possible hazard to the user.**
- **Extra precaution shall be taken to minimize the possibility of shorting the power line with the metal tip of test lead at voltage measurement. It may cause personal injury.**
- **Do not make measurement with the battery cover removed.**

Step 1: Connect the Earth Cord ( black ) to the earth side of the circuit under test and the Line Probe ( red ) to the line side respectively. No need to press the “PRESS TO TEST” button.

Step 2: DC and AC voltage can be measured by setting the function range switch on this instrument to  $\approx V$  position. Press [MODE] button to select AC/DC voltage measuring, and “DC” or “AC” will be on display.

Step 3: Put the tip of the Line probe (red and black) to the circuit. At DC voltage measurement, when applying subtractive voltage to the Line Probe ( red ), subtractive value is displayed on the LCD. Indication  is on display when the measured value greater than or equal to 30V /

less than or equal to -30V.

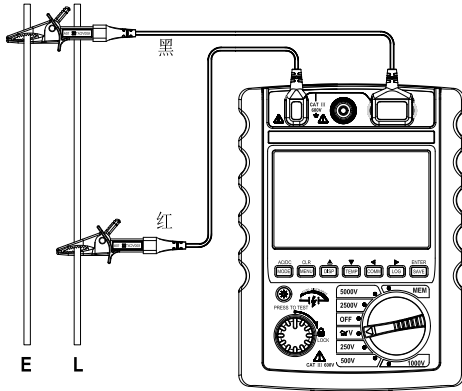

Figure 4

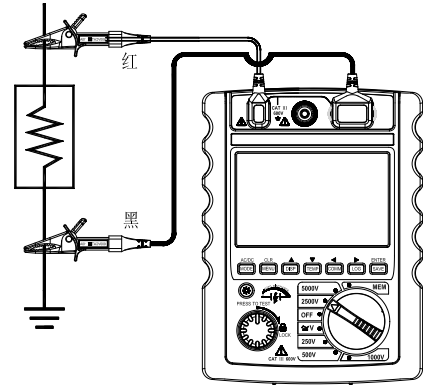

Figure 5

## 7.2 Insulation resistance measurement ( As shown in Figure 5)

### **⚠ DANGER**

- Make sure to check with a high voltage detector that there is no electrical charge exists on the circuit under test. Do not measure insulation resistance of the live circuit.
- Be sure to put on a pair of insulated gloves for high voltage.
- Be extremely careful not to get electric shock during insulation resistance measurement and “PRESS TO TEST” button is being pressed as high voltage is present on the tip of test



leads and on the circuit under test continuously. Things to be measured should be nipped steadily.

- Press the “PRESS TO TEST” to output high-pressure after your hands have left the test clip.
- Do not make measurement with the battery cover removed.

-  **WARNING**
- Do not touch the probe tips together when high-voltage output or measure insulation resistance after high-voltage output, or else it is easy to bring on fire and damage to equipment.

-  **CAUTION**
- When the live circuit warning is indicated or the warning buzzer sounds, measurement cannot be made even if “PRESS TO TEST” button is pressed.
  - Insulation resistance value of the equipment under test may not be stable, and the indication may be unstable.
  - Bleep sound may be heard during insulation resistance measurement. But it is not malfunction.
  - It takes time to measure a capacitive load.

At insulation resistance measurement, positive(+) voltage is outputted from the Earth terminal and negative(-) voltage is outputted from the Line terminal.

Connect the Earth cord to the Earth (ground) terminal.

It is recommended to connect the positive(+) pole to the earth side when measuring insulation resistance against the ground or when a part of the equipment under test is earthed. With this connection, smaller measured value can be obtained comparing with other way round.

Step 1: Check the voltage which can be applied to the circuit under test, and set the range switch to the desired insulation resistance range.

Step 2: Connect the Earth cord(black) to the Earth terminal, and connect the Line probe(red) to the Line terminal.

Step 3: Put the tip of the Line probe(red and black) to the circuit under test.

Step 4: Press the PRESS TO TEST button, and  will be on display.

Step 5: This instrument has an auto-discharge function. With the test leads connected to the circuit under test, release the “PRESS TO TEST” button to discharge capacitance in the circuit after test. Check that the indication on the voltage monitor ( the first secondary display ) is “less than 30V”.



## **DANGER**

- **Do not touch the circuit under test immediately after testing. Capacitance stored in the circuit may cause electric shock.**
- **Leave test leads connected to the circuit and never touch the circuit until the discharge is complete.**

Step6: Set the function range switch to “OFF” position, and remove test leads from the instrument.

Note :

Current of about 40mA (at auto-power off : about 3mA ) is consumed when the range switch is at any range other than “OFF” position. Be sure to turn the range switch to “OFF” position (1uA or less) when not using the instrument.

### 7.2.1 Continuous measurement

Pressing and turning the “PRESS TO TEST” button clockwise to perform a continuous measurement of insulation resistance. Then the button is locked, and continuous measurement can be performed. After testing, turn the button to counterclockwise and set to the initial position.



**DANGER**

**Be extremely careful not to get electric shock as high voltage is present on the tip of test leads continuously.**

### 7.2.2 Timer measurement

This is a function to conduct a test automatically at any set time.

Step 1: For the insulation resistance function, press the [mode] key once to enter the function mode selection, and then enter the stepping mode.

Press the [save] key twice to skip the step mode parameter setting step.

Then press the [mode] key to enter the slope mode.

Then press the [mode] key to enter the timing measurement mode. At this time, the timer

symbol  and "Ms" character on the lower left part of the LCD light up, and the time setting bit of auxiliary display area 1 flashes.

Step 2: Time is set by upper, lower and shift button(▲、▼、▶).

Initial set value: 01:00(MM:SS)

Settable range: 00:10~59:30

Note: As the stabilization time is different when testing different resistances (the larger the resistance, the longer the stabilization time will be), if the time is set too short, the error of test result may be too large.

Step 3: Press [SAVE] button to confirm after set.

Step 4: Pressing and turning the "PRESS TO TEST" button clockwise to perform a continuous measurement of insulation resistance. At the same time, the first secondary display shows measuring time.

Measurement is automatically ended at the set time. The insulation resistance value will be displayed on the primary display. The actual output voltage value will be displayed on the second secondary display. And the measuring time will be displayed on the first secondary display.

Under the timer measurement function, PRESS TO TEST button shall be kept pressed until the set time comes, So it is convenient to use continuous measurement function. When the button is released before the set time comes, measured value at that moment is displayed. When the button is pressed again, measurement can be re-started.

### 7.2.3 Polarization Index measurement ( can be set to any time )

The polarization Index can be measured by the automatic measurement function of the ratio of resistance in arbitrary two point time.

Step 1: Enter the polarization index measurement mode:

Under the insulation resistance function, press the [MODE] button once to enter the setting interface for stepping mode under the function mode.

Press the [SAVE] button twice to skip the steps for parameter setting of the stepping mode.

Press the [MODE] button again, and then enter the ramp mode.

Press the [MODE] button again, and then enter the timed measurement mode.

Press the [SAVE] button once to skip the steps for parameter setting of the timed measurement mode.

Press the [MODE] button again, and then enter the polarization index measurement mode. At this point, the PI sign at the lower part of LCD, TIME1 character at the main display area and the time display mode "**MS**" sign light up; meanwhile, the time setting bit at the auxiliary display zone No. 1 flashes.

Step 2: Time is set by upper, lower and shift button(▲、▼、▶). Set TIME1 first.

Initial set value: 01:00(MM:SS)

Settable range: 00:10~59:30

Step 3: Pressagain [SAVE] button, Time1 mark is displayed at the bottom part of the LCD

After setting TIME1, press the [SAVE] button ,TIME1 mark will be disappeared from the LCD. TIME2 mark will be displayed on the LCD. And time set-bit of the first secondary display flashes. Set TIME2.

Initial set value : 10:00(MM:SS)

Settable range : 00:20~60:00

Note: As the stabilization time is different when testing different resistances (the larger the resistance, the longer the stabilization time will be), if the time is set too short, the error of test result may be too large.

Step 4: Press [SAVE] button to confirm after set.

Step 5: Pressing and turning the “PRESS TO TEST” button clockwise to perform a continuous measurement of insulation resistance. At the same time, the first secondary display shows measuring time, and Time1 mark is displayed at the bottom part of the LCD.

At measurement, PI mark will be displayed on the LCD when TIME1 is set to 1min. and TIME2 is set to 10 min., or else PI mark flashes.

At measurement, Time1 mark will be displayed on the LCD when the measurement time is less than the TIME1 set time. And when the measurement time than the TIME1 set time, Time1 mark will be disappeared from the LCD and Time2 mark will be displayed on the LCD.

Step 6: Measurement is ended at the set time at TIME2, and the PI value is automatically displayed on the primary display. Time2 mark will be disappeared from the LCD. And the measuring time will be displayed on the first secondary display. Indication of “insulation resistance at TIME1”, “insulation resistance at TIME2” and “Polarization Index” can be switched by pressing [DISP] button. When the button is released before the set TIME2 comes, measured value at that moment is displayed. When the button is pressed again,

measurement can be re-started.

Under the Polarization Index measurement function, PRESS TO TEST button shall be kept pressed until the set time comes, So it is convenient to use continuous measurement function. When the button is released before the set time comes, measured value at that moment is displayed. When the button is pressed again, measurement can be re-started.

$$\star \text{ Polarization index} = \frac{\text{resistance value measured after 10min (TIME2)}}{\text{resistance value measured after 1min (TIME1)}}$$

Polarization index	4 or more	4 -- 2	2.0-- 1.0	1.0 or less
Criteria	Very good	good	dubious	unsatisfactory

#### 7.2.4 Dielectric Absorption Ratio ( can be set to any time )

Step 1: Enter the absorption ratio measurement mode:

Under the insulation resistance function, press the [MODE] button once to enter the setting interface for stepping mode under the function mode.

Press the [SAVE] button twice to skip the steps for parameter setting of the stepping mode.

Press the [MODE] button again, and then enter the ramp mode.

Press the [MODE] button again, and then enter the timed measurement mode.

Press the [SAVE] button once to skip the steps for parameter setting of the timed measurement mode.

Press the [MODE] button again, and then enter the polarization index measurement mode.

Press the [SAVE] button twice to skip the steps for parameter setting of the polarization index

measurement mode.

Press the [MODE] button again, and then enter the absorption ratio measurement mode. At this point, the DAR sign at the lower part of LCD, TIME1 character at the main display area and the time display mode "MS" sign light up; meanwhile, the time setting bit at the auxiliary display zone No. 1 flashes.

Step 2: Time is set by upper, lower and shift button(▲、▼、▶). Set TIME1 first.

Initial set value : 00:15(MM:SS)

Settable range : 00:10~59:30

Step 3: After setting TIME1, press the [SAVE] button ,TIME1 mark will be disappeared from the LCD. TIME2 mark will be displayed on the LCD. And time set-bit of the first secondary display flashes. Set TIME2.

Initial set value: 01:00(MM:SS)

Settable range: 00:20~60:00

Note: As the stabilization time is different when testing different resistances (the larger the resistance, the longer the stabilization time will be), if the time is set too short, the error of test result may be too large.

Step 4: Pressto [SAVE] button confirm after set.

Step 5: Pressing and turning the "PRESS TO TEST" button clockwise to perform a continuous measurement of insulation resistance. At the same time, the first secondary display shows measuring time, and Time1 mark is displayed at the bottom part of the LCD.

At measurement, DAR mark will be displayed on the LCD when TIME1 is set to 15 sec.(or 30sec.) and TIME2 is set to 1 min., or else DAR mark flashes.



At measurement, Time1 mark will be displayed on the LCD when the measurement time is less than the TIME1 set time. And when the measurement time than the TIME1 set time, Time1 mark will be disappeared from the LCD and Time2 mark will be displayed on the LCD.

Step 6: Measurement is ended at the set time at TIME2, and the DAR value is automatically displayed on the primary display. Time2 mark will be disappeared from the LCD. And the measuring time will be displayed on the first secondary display. Indication of “insulation resistance at TIME1”, “insulation resistance at TIME2” and “Dielectric Absorption Ratio” can be switched by pressing [DISP] button. When the button is released before the set TIME2 comes, measured value at that moment is displayed. When the button is pressed again, measurement can be re-started.

Under the Dielectric Absorption Ratio measurement function, PRESS TO TEST button shall be kept pressed until the set time comes, So it is convenient to use continuous measurement function. When the button is released before the set time comes, measured value at that moment is displayed. When the button is pressed again, measurement can be re-started.

### **7.2.5 Step voltage measurement**

Step 1: Enter the stepped voltage measurement mode:

Under the insulation resistance function, press the [MODE] button once to enter the setting interface for stepping mode under the function mode. At this point, the SV sign at the lower part of LCD, TIME character at the main display area light up and the time setting bit at the auxiliary display zone No. 1

flashes.

Step 2: Set parameters for each stepping time

Press the Up and Down button ([DISP]/[TEMP]) and the shift button ([COMM]/[LOG]) to set the TIME.

Set the initial time value: 10S

Setting Range: 1-90S

Note: As the stabilization time is different when testing different resistances (the larger the resistance, the longer the stabilization time will be), if the time is set too short, the error of test result may be too large.

Step 3: Press the [Save] button for confirmation after the setting. At this point, display STEP character in the main display area of LCD; meanwhile, the time setting bit at the auxiliary display zone No. 1 flashes.

Step 3: Set the stepping order parameters

Press the Up and Down button ([DISP]/[TEMP]) and the shift button ([COMM]/[LOG]) to set the TIME.

Set the initial value of the order: 5

Setting range:1-99

Step 4: Press and lock the test button to start the test, and the auxiliary display zone No.1 area displays the current order.

Step 5: The measurement will automatically terminate when the set number of steps completes, and the insulation resistance value of the last step will be automatically displayed in the main display area. The order at the auxiliary display zone No. 1 will no longer change. Press [DISP] button to view the insulation resistance value at each step.

Under the Step Voltage measurement function, PRESS TO TEST button shall be kept pressed until the set time comes, So it is convenient to use continuous measurement function. When the button is released before the set time comes, measured value at that moment is displayed. When the button is

pressed again, measurement can be re-started.

### 7.2.6 Ramp voltage measurement

Ramp the voltage up over a certain period of time (the voltage rises from minimum to maximum in 120 steps in 60S) and measure the insulation resistance at each voltage segment. Compared with the stepped voltage mode, the parameters of the ramp voltage mode are fixed, with no need to set the parameters by users.

Step 1: Enter the ramp voltage measurement mode:

Under the insulation resistance function, press the [MODE] button once to enter the setting interface for stepping mode under the function mode.

Press the [SAVE] button twice to skip the steps for parameter setting of the stepping mode.

Press the [MODE] button again to enter the ramp mode; at this point, the **RAMP** sign at the lower part of LCD lights up.

Step 2: Press and lock the test button to start the test, and time travels at the auxiliary display zone No.1 area. The measurement will automatically terminate when the 60S finishes, and the insulation resistance value of the last step will be automatically displayed in the main display area. The total number of steps displays at the auxiliary display zone No.1 area. Press the [DISP] button to view the insulation resistance value at each step.

When measuring the ramp voltage, press the test button until the 60S runs out. At this point, it is convenient to use the function of continuous measurement. If you release the button before reaching the 60S, the current measurement value will be displayed, and the measurement starts again after you press the test button again.

Fault mode: under the ramp voltage measurement mode, if a sharp drop in applied voltage due to insulation deterioration such as a fault or sudden current rise is detected, the test is terminated at the point of time where the sharp drop is detected to avoid more serious damage, and the test continues if no fault or sudden current rise is detected

### 7.2.7 Leakage Current measurement

At Continuous measurement or Timer measurement, indication of “insulation resistance” and “leakage current” can be switched by pressing [DISP] button.

### 7.3 Voltage characteristics of measuring terminal

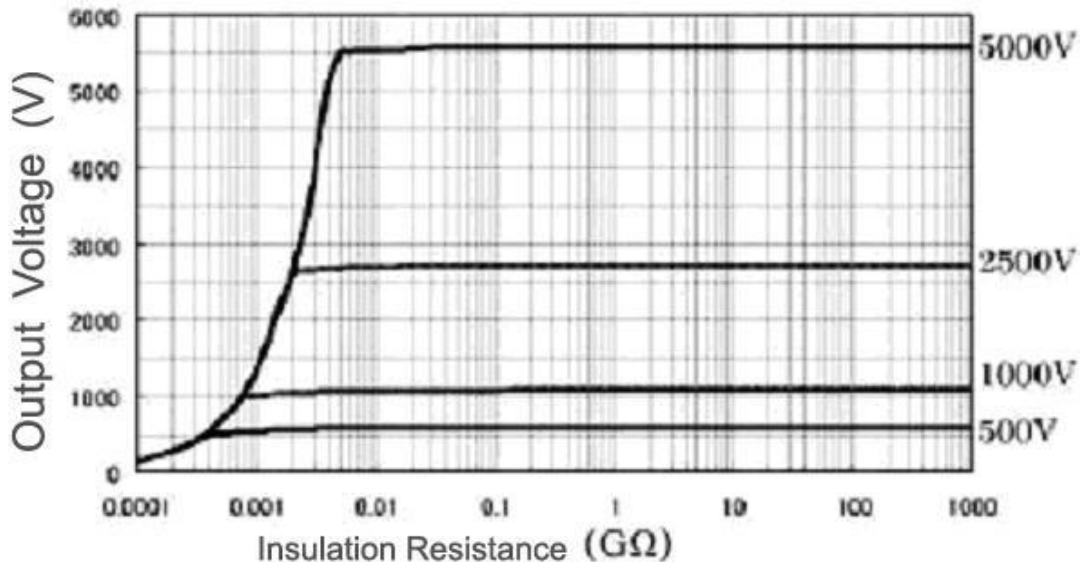

Figure 6

#### **7.4 Use of Guard terminal**

When measuring the insulation resistance of a cable, leakage current flowing on the surface of cable jacket and the current flowing inside the insulator are mixed and may cause error in insulation resistance value. In order to prevent such error, wind a conductive wire around the point where leakage current flows. Then connect it to the Guard terminal as shown in below figure. This is to move out the surface leakage resistance of the cable insulation to measure only the volume resistance of insulator. Make sure to use the Guard cord supplied with this instrument to connect the instrument to Guard terminal.

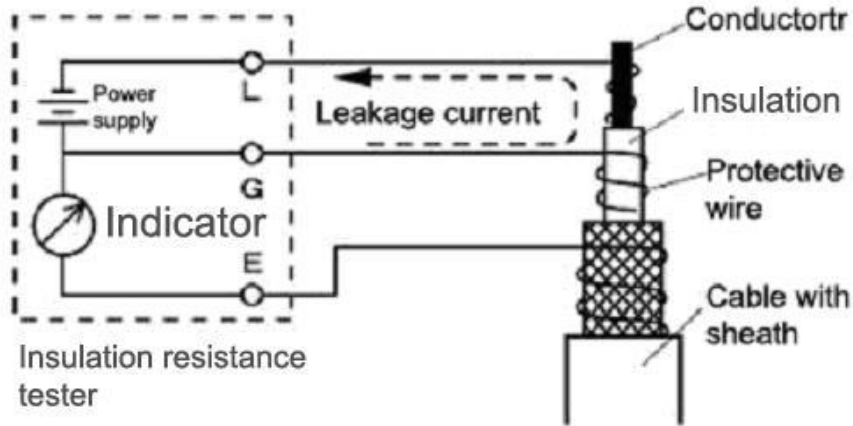

Figure 7

### 7.5 Temperature display ( not LOGG mode)

Under the insulation resistance range or voltage measurement, the auxiliary display area 1 is clock display by default, and the current ambient temperature can be displayed by pressing the [TEMP] key. To convert Fahrenheit to centigrade, please refer to Chapter 9 "changing instrument settings".

To exit the temperature display, just press the [TEMP] button to return to the clock display.

### 7.6 Time display

In the insulation resistance range (non operation storage log) or voltage measurement, auxiliary display

area 1 is clock display by default. To set or change the time and date, see "changing instrument settings" in Chapter 9.

## 8. Using Memory & Communications Features

### 8.1 Data Storage



The meter has two types of memory data : SAVE mode and LOGG mode.

- Undertake “clearing memory data” operation first if the data storage functions are used firstly.
- LOGG mode is unavailable when the meter is in TIME, PI, DAR, SV function.
- SAVE mode is available when the meter is in TIME, PI, DAR, SV function.
- Records number is displayed on the first second display when storing data. When “FULL” on the LCD indicates data storage is full and will stop saving.
- In LOG mode, no data could be saved if there is a recording ( no matter the storage is full or not ). The user should clear off the memory and then start to save. In LOG mode, the meter will auto-stop data storage when the storage is full.
- Low battery indicator  appears on the screen to indicating forbid saving.

### Memory Capacity

Memory	Memory Capacity
SAVE mode	260
LOG mode	500

### 8.1.1 SAVE mode

Press  ,  appears in the display. If the storage is not full, well then records number on the first secondary display. After one second, return to the original show. **FULL** will be show on the second secondary display when records number is 260. It means that the storage is full and can not save data.

Press  to complete a manual save. At this moment, records number automatic add one.

### 8.1.2 LOG mode

Proceed as follows:

Step 1: Set the interval time of storage real time data ( see Chapter 9“Changing the Default Setting” ).

Step 2: Press [LOG] button to start log mode. A t the moment,  appears in the display. And records number is displayed on the first secondary display. The meter will auto-stop data storage when the storage is full.

Step 3: To exit LOG mode, press [LOG] button.

### 8.1.3 Viewing Memory Data

Use the following procedure to view memory data:

Step 1: Disconnect the test leads at the measurement circuit.



#### **WARNING**

**To avoid electric shock, disconnect the test leads when the range switch is in the MEM**



## position.

Step 2: Turn the range switch to the MEM position and read the last SAVE record in meter default state. At the moment, **MEM** appears in the display. Long Press [LOG] button for logged reading, **LOG** appears in the display.

Step 3: Press ▲ or ▼ to forward / backward to read the current record of data. Press ► to display the remaining information when reading SAVE data. ▲, ▼ and ► are void if the storage is empty.

Step 4: To enter measurement mode, please set the function range switch to any position other than “MEM”.

### 8.1.4 Clearing Memory

Use the following procedure to clear memory data:

Step 1 : Disconnect the test leads at the measurement circuit.



#### **WARNING**

**To avoid electric shock, disconnect the test leads when the function range switch is in the MEM position.**

Step 2 : Turn the range switch to the MEM position and read the last SAVE record in meter default state. At the moment, **MEM** appears in the display. Long Press [LOG] button for logged clearing, **LOG** appears in the display.

Step 3 : Press[MENU] button, **MEM** appears in the display and press[MENU] button again to clear the

type of memory presently; **YES** on screen, confirm clear this area data, after 1s display “----”; else press ▲ or ▼ or ► or  button to cancel.

Step 4 : To enter measurement mode, please set the function range switch to any position other than “MEM”.

## 8.2 Using Communications

### CAUTION

**Make sure your PC has been connected with the earth ground when employing this function.**

Please operate according to the following steps:

Step 1: Push aside the movable valve on the side of the instrument, and plug one end of the USB to into the USB jack of the instrument, and connect the other end to into the USB port of the computer (see Figure 8).

Step 2: Power the instrument and turn the cutter head to  to boot up the instrument.

Step 3: Press the [COMM] button to enable the communication enabling function, and then the COMM character at the lower left corner of the LCD lights up.

Step 4: communication.

Step 5: Upon the completion of communication, press the [COMM] button again to disable the communication enabling, and the COMM character at the lower left corner of LCD is OFF.

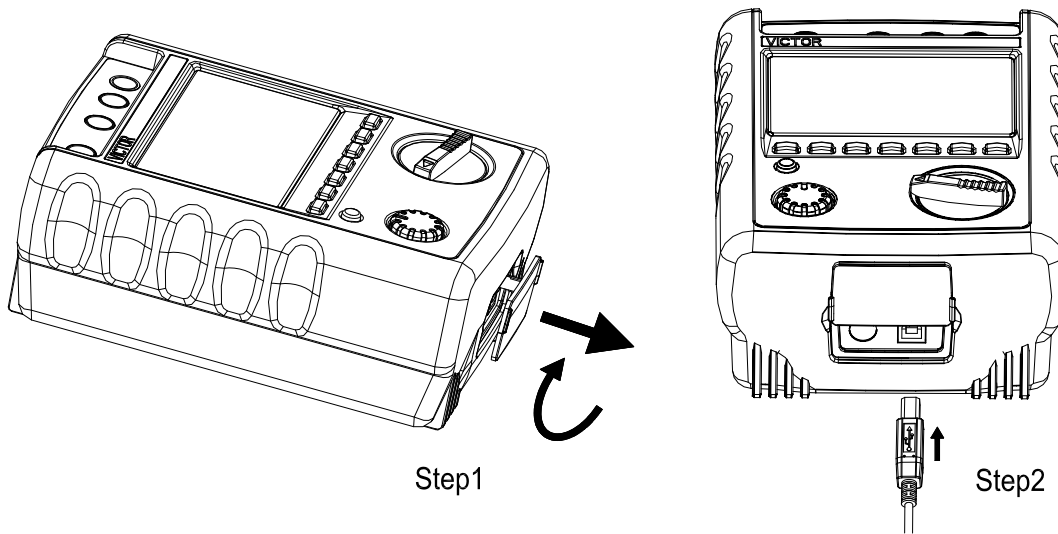

Figure 8

## 9. Changing the Default Settings

The meter allows you to change the default-operating configuration of the meter by changing setup options made at the factory.

Many of these setup options affect general meter operations and are active in all functions. Other are

limited to one function or group of functions.

Selection		Function	Factory Default
<b>APDF</b>	Power off time	Set Range:0~60min. Set zero to cancel auto power-off function. Use ▲ or ▼ to increment or decrement digit. Use ► to select digit flashes.	10 minutes
<b>BLDF</b>	Backlight time	Set Range:0~3600 s. Set zero to cancel auto turn backlight off function. Use ▲ or ▼ to increment or decrement digit. Use ► to select digit flashes.	10 seconds
<b>LGtE</b>	LOGG mode interval time	Set value : 15/30s/1/2/5min. Use ▲ or ▼ to increment or decrement digit.	15 seconds
<b>tENP</b>	Temperature units	Use ▲ or ▼ to select °C or °F.	°C
<b>bEEP</b>	Buzzer	Use ▲ or ▼ to select YES or NO.	ON
<b>rELr</b>	Setting of resistance limit range	The setting range includes 100MΩ, 1000MΩ, 10GΩ, 100GΩ, 1000GΩ and 5TΩ; Use ▲ or ▼ button to change the setting range. The factory default range is 5TΩ.	5TΩ
<b>rEL'</b>	Setting of resistance limit	Use ▲ or ▼ button to increase or decrease the set value.	4.99TΩ
<b>dAtE</b>	Date	Set Range: 2000.01.01~2079.12.31. Use ▲ or ▼ to	2000.01.01

		increment or decrement digit. Use ► to select digit flashes.	
Ⓛ Ⓝⓔ	24-Hour	Set Range: 00: 00~23: 59. Use ▲ or ▼ to increment or decrement digit. Use ► to select digit flashes.	00: 00
FACT	Restore factory default	Press[SAVE] button, <b>SAVE</b> appears in the display to indicate return to the factor default (exclude <b>DATE</b> , <b>Ⓛ Ⓝⓔ</b> , <b>FSE</b> ).	

## 9.1 Selecting Setup Options

To enter the Setup mode, press \* when the meter is in Voltage or Insulation resistance measurement function. (When the “PRESS TO TEST” button is not pressing).

In the Setup mode, each setup option appears in the primary display and the default value appears in the first and second secondary display. Press \* to change the setup option. Press <sup>LOG</sup><sub>SAVE</sub> to store the set value ( SAVE on the second secondary display indicates the maintained has been stored.).

After the “Restore factory default”, press \* to exit the adjust mode,

Notice : It is necessary to press <sup>LOG</sup><sub>SAVE</sub> to store the set value after changed any setup option.

Press <sup>LOG</sup><sub>SAVE</sub> to store the last set value.

## **10. Battery replacement ( As shown in Figure 9 )**

Step 1: Set the range switch to “OFF” position, and remove the test leads from the instrument.

Step 2: Loosen the battery compartment cover fixing screws, and remove the battery compartment cover. Always replace all 8 batteries with new one at the same time.

Step 3: After replacing batteries, be sure to tighten up the screw for battery compartment cover.



### **DANGER**

- **Never open the battery compartment cover while making measurement.**



### **WARNING**

- **To avoid possible electric shock, remove test leads before opening the battery compartment cover. After replacing batteries, be sure to tighten up the screw for battery compartment cover.**



### **CAUTION**

- **Do not mix new and old batteries.**
- **Make sure to install batteries in correct polarity as marked inside.**

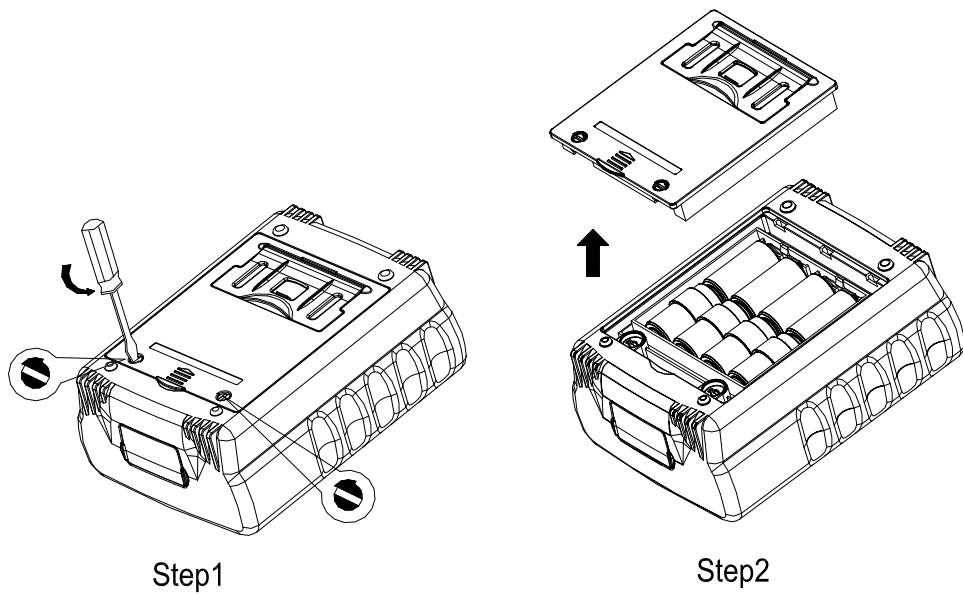

Figure 9

## 11. Special-purpose power source adapter use method ( As shown in Figure 10)

### CAUTION

**Please use the special-purpose power source adapter by us, or else it may damage the meter.**

Push aside the sliding door on the flank of the instrument. Choose the special-purpose power source adapter of the instrument to plug in power supply socket. (Make sure the instrument is off when you plug in or push aside the special power supplies adapter. And you'd better set down the battery when you use the special power supplies adapter. )

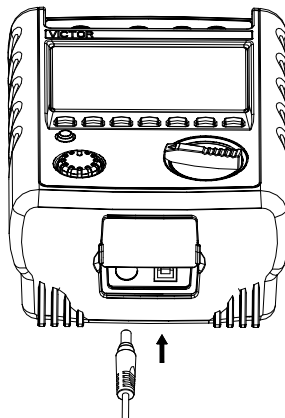

Figure 10



## **12. Maintain & Maintenance**

Periodically wipe the case :

Periodically wipe the case with a damp cloth and mild detergent.

To avoid damaging the meter, never get water inside the case. If the meter is wet, please dry it then pack away.

Repair and calibration must be performed by qualified personnel.

## **13. Notice of the Instruction Manual**

- The present operation instruction is subject to change without notice.
- The content of the operation instruction is regarded as correct. Whenever any user finds its mistakes, omission etc., he or she is requested to contact the manufacturer.
- The present manufacturer is not liable for any accident and hazard arising from the customer misuse or inadvertent operation.
- The functions described in this operation instruction should not be used as grounds to apply this product to a particular purpose.