



MODEL: GM1356

Sound Level Meter Instruction Manual



Specific Declarations:

Our company shall hold no any responsibility resulting from using output from this product as an direct or indirect evidence.
We reserves the right to modify product design and specification without notice.

CE  Version: GM1356-0

Contents

1. Before use notice

- Check up------(01)
- Introduction------(02)
- Features------(02)
- Diagram of the unit------(03)
- LCD Displays------(05)
- Specifications ------(07)
- Calibrations------(08)
- Calendar setting----- (09)

2.Operation instructions

- Battery installment------(10)
- Selection measure level------(11)
- Time weighting selection------(15)
- Frequency weighting selection------(16)
- The maximum value measurement------(17)
- Data storage------(18)
- Data clearance------(19)
- Connect with PC------(20)

3. Other items

- Trouble shooting------(36)
- Attention------(36)
- Maintenance and warranty------(37)

Maintenance and warranty

1). Maintenance

- Replacement and maintenance of battery:
 - a.Remove the battery from the unit if it is not required for extended periods of time in order to avoid damage to the battery compartment and the electrode resulting from a leaking battery.
 - b.After power on, if a symbol  appears on the LCD, you need to replace the batteries immediately. Open the battery door, take out the old battery install new batteries, (note the battery polarity), then close the battery door, for details please refer figures and contents on page 10 of this manual.
- Cleaning the casing:

Never use alcohol or thinner to clean the unit casing that will especially erode the LCD surface; just clean the unit lightly as needed with little clean water.

2). Warranty

- About relative warranties please read provided warranty card.
- We disclaim any liability due to: transportation damages; incorrect use or operation; manipulation, alterations or repair attempts; without warranty card, invoice.



Specific Declarations

- a. We reserve the rights of the update and amendment of the product design and the manual which are subject to change without further notification.
- b. Dispose of battery should in accordance with local laws and regulations.

3. Other items

Familiar trouble shooting

The following is a list of actions to be taken if the unit is not working properly:

1). Screen is Blank:

Check the batteries are installed correctly. Open the battery door on rear of the unit. The + and - symbols on the battery should match the corresponding + and - symbols marked in the battery compartment.

2). If the unit can not connect to PC normally, please check if the USB cable is OK, if the cable can not be used formally, please replace it for a new one.

Attentions

1). Environment conditions on operation:

Indoor use; 2000 meters high below;
Temperature:0~40°C;
Relative humidity: ≤80%RH

2). Do not store or use the unit in following conditions:

- a. Splashes of water or high levels of dust.
- b. Air with high salt or sulphur content.
- c. Air with other gases or chemical materials.
- d. High temperature or humidity or direct sunlight.

3). Never impact the unit or used on humidity conditions.

1. Before use notice

Check-up

Carefully unpack your kit after you purchased this product and ensure that you have all the following items. In the event that any items is missing or if you find any mismatch or damage or the manual appearing to lack page, etc. Seriously influencing the reading, promptly contact your dealer.

○ Sound level meter	1PCS
○ Sponge ball	1PCS
○ Computer software disc	1PCS
○ USB connection cable	1PCS
○ AC output wire	1PCS
○ 1.5V Alkline battery	4PCS
○ Instruction manual	1PCS
○ PP packing box	1PCS

Introduction

This unit has been designed to meet the measurement requirement of noise engineers, noise quality control and health prevention in various environments, such as noise measurement in factory, office, traffic road, family and all other noise measurement applications.

Features

- This unit was designed according to following standards:
 - a. International electrician committee standard:
IEC PUB 651 TYPE2
 - b. US national standard: ANSI S1.4 TYPE2
- Accuracy up to +/-1.5dB
- Measurement range is 30 to 130dB
- Fast/Slow Time weighting selection
- Automatic backlight
- The maximum value holding function
- Auto power off 10 minutes
- A/C Frequency weighting selection
- Both AC and PWM signal output are available
- Calendar function
- 4700 data record function
- Connect with the PC through USB, provides data record downloading, real-time data sampling analysis, and printing graph&data functions.

- Click the Import Data in File menu bar or Import Data button on tool column will popup as the following picture shows:

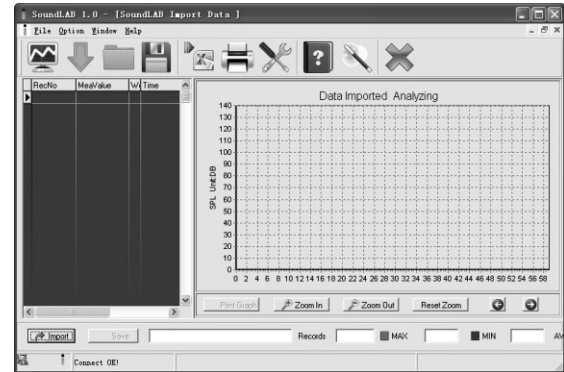

- Click “Import” to import the data stored in the sound level meter, which will display as Data curve!

NOTE:

This software supports to print measuring data curve diagram, for details please refer to HELP content.

6) On line measurement:

○ Click Real Time Measure in File menu bar or Real Time Measure button in tool column will enter into the window as the following picture shows:

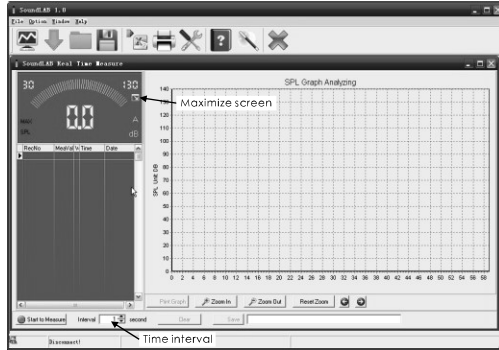





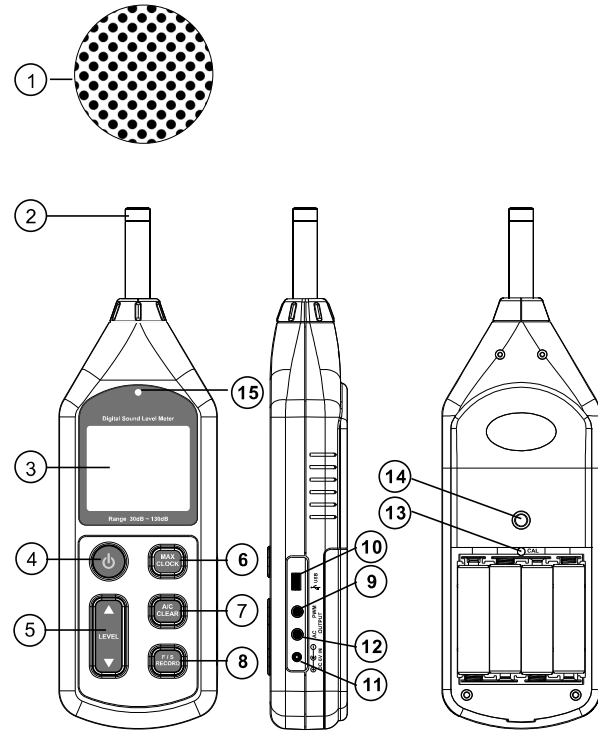

○ Button instructions:

Button	Function
	Click to start real-time measurement
	Click to stop real-time measurement
	Click to clear all the measuring data
	Click to store real-time measuring data, input file name in popup window, click to save the document format of Lab.
	Click to print curve diagram
	Zoom in curve diagram
	Zoom out curve diagram
	Reset zoom, resume to defaulted value
	Move curve diagram to left or right

Diagram of the unit



1. Sponge ball (when outdoor use please put on, prevent wind blowing noise disturbing the unit reading)
2. Capacitance microphone
3. LCD display
4.  : Power on switch
5. **▲LEVEL▼** : Level position switching and calendar setting key.
6.  : Maximum value holding and calendar setting key.
7.  : Frequency weighting selection and record data deletion key, the default value is A, press once turn to be C, press down until on the LCD appears the symbol CLR will delete all the record data.
A: Weighting for general sound level measurements.
C: Weighting for checking the low-frequency content of noise.
8.  : Time weighting selection and data recording key, the default value is FAST, press once turn to be SLOW, press down until on the LCD appears the symbol RECORD will enter data recording mode, press again to exit to this mode.
FAST: Displaying current instantaneous dB value
SLOW: Displaying current average dB value in 1 second.
9. **PWM** : Pulse Width Modulation output jack
10.  **USB** : USB jack
11. **DC 6V IN** : DC 6V input jack
 (outside positive inside negative)
12. **AC OUT** : AC analog signal output jack
13. Calibration knob
14. Tripod fixed screw aperture
15. Light sensor

- Click “PC Software Setting” to setup the Low/ High dB Alarm, and the Alarm sound ON/OFF. Then click “OK” or “Apply” to confirm. As the following picture shows:

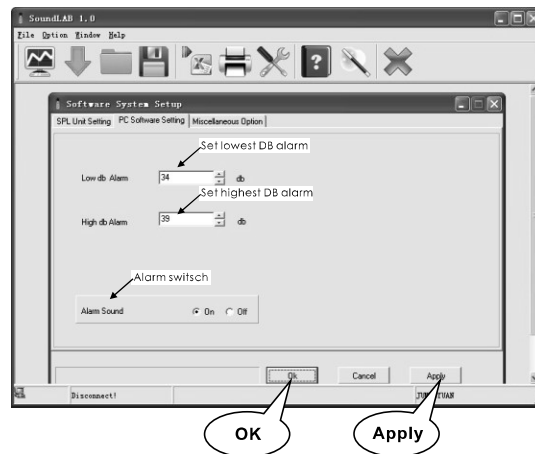

- Click “SPL Unit Setting” to setup the following items: Measurement range, Max work mode, Sample speed, weight, ect. Then click “OK” or “Apply” to confirm. As the following picture shows:

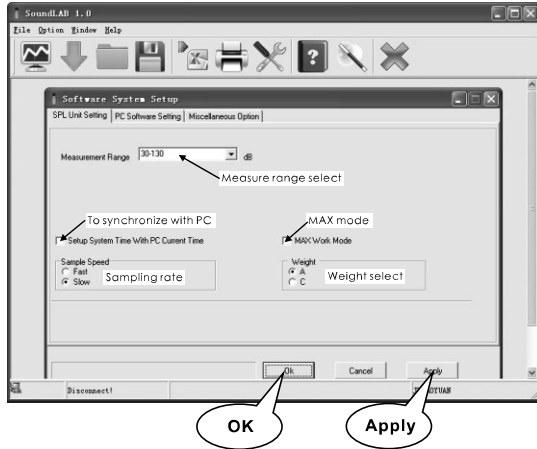

LCD Display

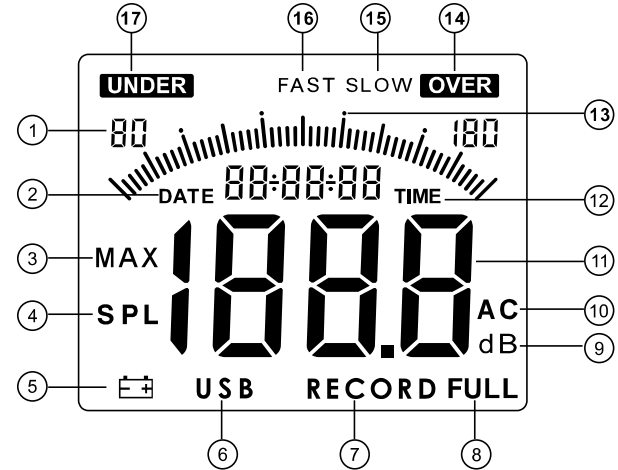

1. Level range
2. **DATE** calendar date (year, month, day)
3. **MAX** The maximum value icon
4. **SPL** Sound pressure level icon
5.  Low battery indication
6. **USB** USB communication icon
7. **RECORD** Data recording icon
8. **FULL** Data recording full indication
9. **dB** Measurement unit
10. **AC** frequency weighting A and C
11. Reading displaying area
12. **TIME** Calendar clock (hour, minute, second)
13. Bar graph (1dB/1 bar graph)
14. **OVER** Alarm symbol, if the reading is over the maximum range, this symbol will display.
15. **SLOW** Slow time weighting (refers to respond speed)
16. **FAST** Fast time weighting (refers to respond speed)
17. **UNDER** Alarm symbol, if the reading is under the minimum range, this symbol will display.

5). System setup:

Click “Option” > “System Setup” or click to enter the “System Option” the default setup is “Miscellaneous Option”. Enter the company name if you need, click “Ok” or “Apply” to confirm the setting.
As the following picture shows:

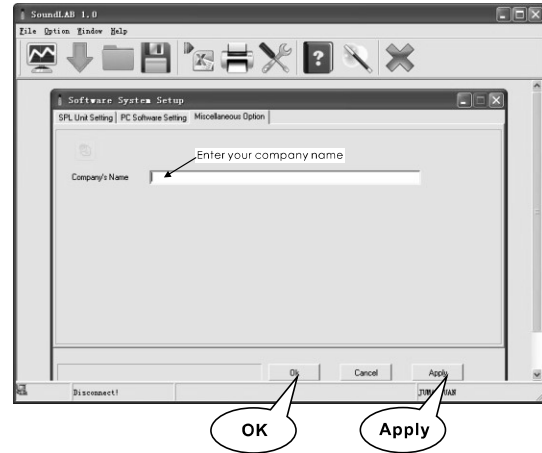

4) Connection with PC:

- Insert one end of USB wire into the USB socket on the unit, as the following picture shows:

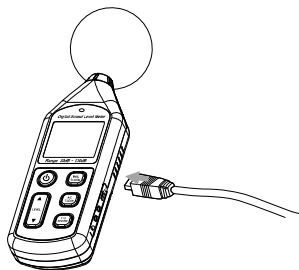

- Plug another end of USB wire into the interface port on PC, as the following picture shows:

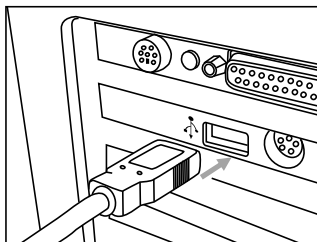

Note:

- Once the connection is done, an USB icon appears on the LCD of the unit indicates a success connection, otherwise, the connection fails.
- In connection with PC, the PC could supply the power to the unit directly, in absence of 4 *AA batteries. When disconnect with the PC, the unit will auto turn off.

Specifications

Calibration sound source	94dB@1KHz
Measurement range	30~130dBA、35~130dBC
Accuracy	±1.5dB (reference sound pressure standard, 94dB@1KHz)
Frequency response	31.5Hz~8.5KHz
Resolution	0.1dB
Measuring level	30 to 80, 50 to 100, 60 to 110, 80 to 130, 30 to 130
Dynamic range	50dB/100dB
Overload indication	OVER / UNDER
Frequency weighting characteristic	A and C
Digital display	4 digits
Analogy bar graph	1dB/1 bar graph
Sampling rate	FAST:8times/second;SLOW:2times/second
AC signal output	4Vrms/ full bar graph, output impedance is about 600 ohm
PWM signal output	Duty cycle = $\frac{0.01 \times db \text{ value}}{3.3} \times 100\%$
Dynamic characteristic	FAST(high speed)/SLOW(low speed)
Calendar accuracy	±30seconds/day
Data storage quantity	4700
The maximum value holding	MAX
Auto power off	10 minutes without operation
Microphone	1/2inch polarization capacitance microphone
Power supply	6V (4PCS 1.5V Alkline battery)
Dimension	70x35x256mm
Weight	244G (Without battery)
Battery life	20h continuous use(Alkaline batteries)

Calibration

Please use 94dB@1KHZ standard calibration instrument

1. Open battery door and insert the batteries into the battery compartment properly.
2. Setting on sound level meter: Frequency weighting is A; Time weighting is FAST; Level range is 60 to 110dB. Shown in the Figure 1:

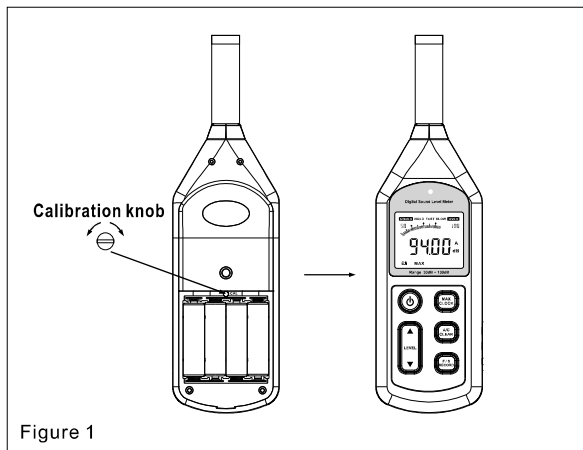

Figure 1



Note:

Our products are all well calibrated before Shipment.
Recommended recalibration cycle: 1 year.

Command	Function
Real time measure	Real-time data measurement, the measured data at real time will be displayed on computer screen
Open save	Open measuring data file in Lab format
Import Data	Save real-time measurement data
Export Data	Download the measurement data
Printer Setup	Export the measuring data into excel format
Print Data Sheet	Printer setting
System Setup	Print data sheet
Language	System setting
	Language selection of software contact interface

Tool column instruction as the following picture shows:



Button	Function
	Real-time data measurement, the measured data in real time will be displayed on computer screen
	Download the data stored in the sound level meter to computer
	Open measuring data file that is saved as Lab format
	Save real-time measurement data
	Save the measured data as Excel document
	Print data sheet
	System setup
	Help
	System information
	Close this software

3) Software instruction

- The software window as the following picture shows :



- Menu instruction as the following picture shows:

File menu bar:

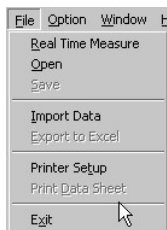

Option menu bar:



Note:

Check if this unit is connected well to the computer on state column:

Connect OK: Connect successful;

Disconnect: failed to connect.

Calendar setting

- 1> Setting date and clock with button:

When the unit is power-off, press key and the key to turn on, the LCD screen flashes the first digit of calendar year, as shown in figure 2:

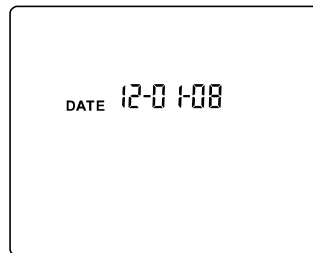

Figure 2

at this time you can release the key, press the LEVEL or key to adjust the digital of year, month and day, after adjust the first digit, press the key turn to adjust second digit, Follow such steps, when you press down this key at sixth time, you can start the adjustment of hour and minute, after minute adjustment finished press down key once again to withdraw from calendar adjustment mode.

- 2> Setting date and time with PC connection:

Click OPTION>SYSTEM SETUP, select SYSTEM SETUP TIME WITH PC CURRENT TIME, then click ENTER, on the computer displayed time will be downloaded into this unit.

2. Operation instructions

Battery installment

1. Open the battery door and insert 4 pieces 1.5V AA battery into the battery compartment.
2. Cover the battery door.
3. When the battery voltage drops below the operating Voltage, mark "E+" appears, please replaced with new batteries.
4. When the DC adapter is used, insert the plugs (3.5 ϕ) of the adapter into the DC 6V connector.

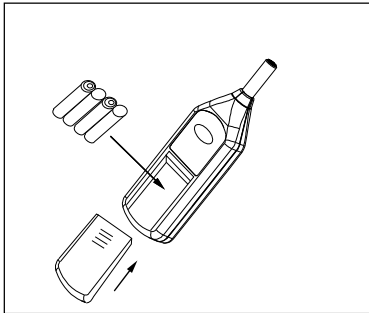

- When this interface appears, click “Finish” to finish the installation.
As the following picture shows:



Click to finish the installation

- If it is first time to install this software, you have to install the Database.
When this interface comes out, click “Install” to start the installation. As the following picture shows:



Selection measurement level

- Press the  key to turn on the unit, after the LCD entire screen displays for 2 seconds will display the year, month and date. As shown in figure 3:

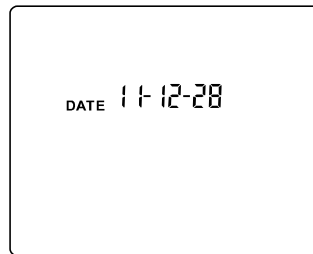

Figure 3

- After 3 seconds it enters default measurement mode, as shown in figure 4:

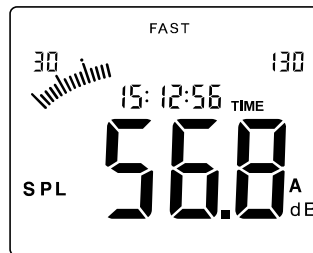
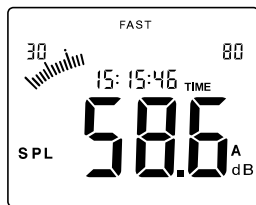

Figure 4

- Press the LEVEL ▲ or ▼ key, select your desired measuring level: 30 to 80, 50 to 100, 60 to 110, 30 to 130(auto) the LCD screen displays as follows:

30~80:



50~100:

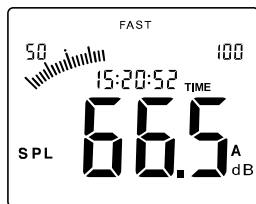

60~110:

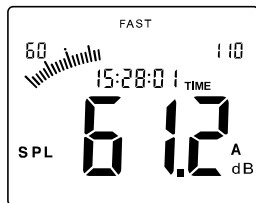

- When this interface comes out, make sure to select the "Setupbde (DataBase access engine)" if it is the first time to install this software on this computer, click "Finish" to install the DataBase access engine; If this is not the first to install this software, you need not select "Setupbde".

For starting this software right now, select "Run SoundLAB", click "Finish" to finish the installation.

As the following picture shows:



Finish the installation

- Click “Install” to start the installation, as the following picture shows:



80~130:

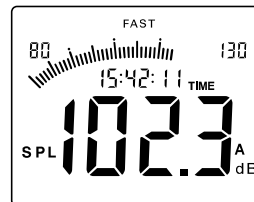

30~130:

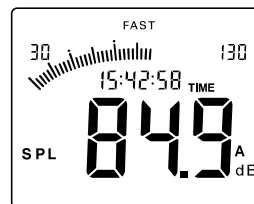

- If your set measuring level is higher than the environment level, for example level 60~110 is set, and current actual sound level is lower than 60dB, the LCD screen will display the icon **UNDER**, please press ▼ key to lower the level until the icon **UNDER** disappears. As shown in figure 5:

Figure 5

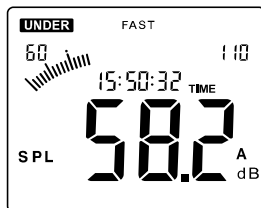

- If your set measuring level is lower than the environment level, for example level 30~80 is set, and current actual sound level is higher than 80dB, the LCD screen will display the icon **OVER**, please press ▲ key to lower the level until the icon **OVER** disappears. As shown in figure 6:

Figure 6

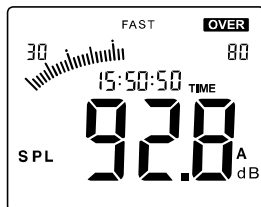

Note:

- If the measuring level is set as 80~130, the LCD still display the icon **OVER**, that indicates the current noise level is exceeding the measuring range of this unit;
- If the level is set 30~130, the unit can auto switch level.

- Select “Create a desktop Icon” if you want to create a desktop icon, then click “NEXT” to enter next step, as the following picture shows:

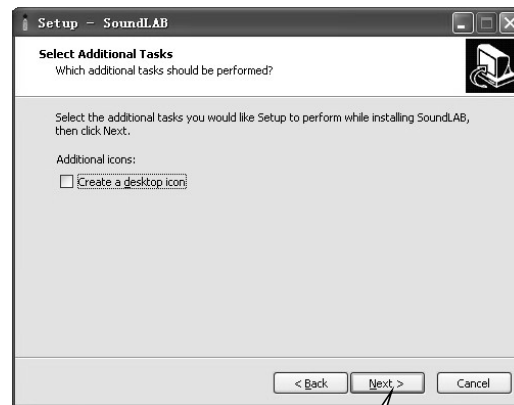

Click to enter next step

- When this Interface comes out, click “Next” to enter next step, as the following picture shows:



Time weighting selection

The default time weighting is FAST after power on, the LCD screen displays as in figure 7:

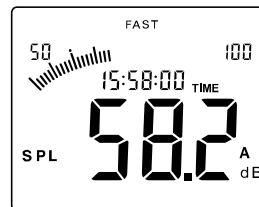

Figure 7

Press the **F/S RECORD** key to turn into SLOW (low speed), the LCD screen displays as in figure 8:

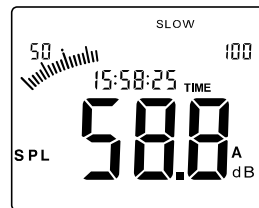

Figure 8



Note:

- Selecting FAST is to pick up the current reading;
- Selecting SLOW is to pick up the reading of average within 1 second.

Frequency weighting selection

The default frequency weighting is A after power on, the LCD screen displays as in figure 9:

Figure 9

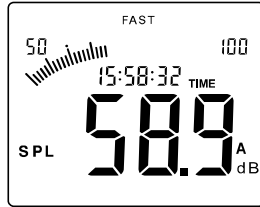

Press once the  key the frequency weighing will turn into C, the LCD displays as in figure 10:

Figure 10



Note:

A-Weighting for general sound level measurements.
C-Weighting for checking the low-frequency content of sounds.

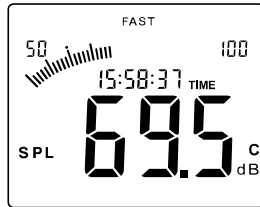
- Click “Browse” to change the installation folder, click “Next” to enter next step, as the following picture shows:

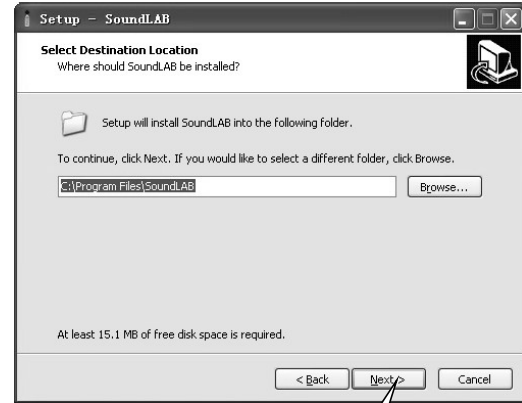

Click to enter next step

Connection with PC

1). Requirements of computer configuration:

- CPU: PentiumIII 600MHZ or above;
- One free available USB connecting interface;
- The lowest screen resolution of monitor is 800*600 (or much higher), true color;
- At least 8MB available memory;
- At least 50MB available disk memory;
- Operation system: Microsoft windows XP/VISTA/ windows 7

2). Installing the data collecting software:

- Place the software disc in your disc driver, open the disc driver file, double-click the Setup.exe program icon to enter program installation contact interface, click NEXT to enter Next step, as the following picture shows:



Click to enter next step

The maximum value measurement

- During measurement process, press the **MAX/CLOCK** key to lock up the maximum reading, the LCD displays as in figure 11:

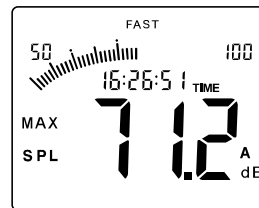

Figure11

- Press it again to exit the maximum value measurement and return normal measurement mode.

Data storage

- Press down the  key until the LCD screen appears the symbol 1, then press LEVEL ▲ or ▼ to adjust the record interval, finally press  to enter into the data storage mode, LCD screen displays as in figure 12:

Figure 12

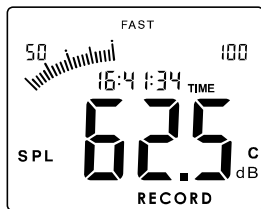

- The memory capacity is 4700, after long period of recording, the LCD screen will appear the symbol FULL, as shown in figure 13:

Figure 13

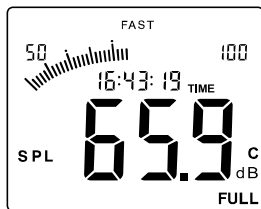

- In data storage process or recording memory is full, press  key again to exit the record mode, the flashing symbol RECORD will disappears.

Data clearance

- Press down the  key until the LCD screen displays the symbol CLR, then all recorded data will be deleted, LCD displays as in figure 14:

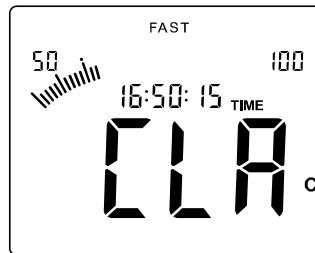

Figure 14