

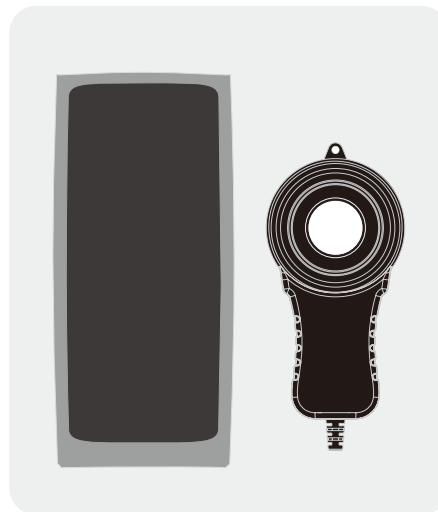

MODEL: GM1050

Split illuminance meter instruction manual



Android version iOS version

Table of contents

I. Product Introduction-----	(02)
II. Product Features-----	(02)
III. Name and function of each component -----	(02)
IV. LCD display-----	(03)
V. Functional operation -----	(04)
VI. Parameters -----	(05)
VII. App Operation Instructions -----	(06)
VIII. Connection between host and PC -----	(11)

I. Product introduction

A split illuminance meter is a professional instrument for measuring luminosity and brightness. It is used for light intensity measurement engineering, quality control, health prevention, and light intensity measurement in various environments, such as factories, schools, offices, traffic routes, homes, etc.

II. Product Features

This split-type illuminance meter not only has the function of measuring illuminance and current value, maximum value, minimum value and difference; the alarm function of illuminance exceeding the default setting; it also has the function of illuminance value maintenance and illuminance temperature detection; Bluetooth mobile phone APP communication and computer communication function ; measurement statistics illuminance integral, integral average and data recording functions.

1. Switchable illuminance units (Lx/Fc) and temperature units (°C/°F).
2. By default, the high alarm is set to 20,000; the low alarm is 0; the set value is not related to the unit.
3. Automatic range; sensitive response; be able to measure low-light environment (<10Lx).
4. Automatically shut off without operation for a long period of time can be turned on.
5. Fc: foot candlelight; Lx: lux; conversion relationship: 1Fc = 10.764Lx

III. Name and function of each component

1. Switch
2. Hold/calibrate the zero point
3. Bluetooth/sound alarm
4. Switch the measurement mode
5. Switch the illuminance unit
6. Record/delete
7. Luminance head (illuminance head)
8. Shading cover
9. USB charging interface

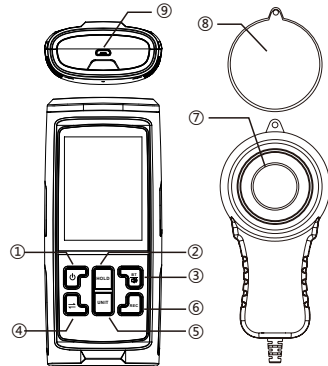

IV. LCD display

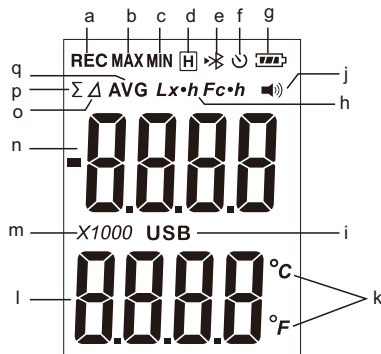

- a. Data recording
- b. Maximum value
- c. Minimum value
- d. Data hold
- e. Bluetooth
- f. Timed shutdown
- g. Power and charging display
- h. Illuminance units
- i. USB connection status

- j. Sound alarm
- k. Temperature units
- l. Temperature value display area
- m. Multiplier of illuminance value
- n. Illuminance value display area
- o. Difference display
- p. Integral value
- q. integral average

Note: When " " appears, please charge it in time, otherwise the measured value may be distorted, Bluetooth communication is abnormal.

V. Functional operation

1. On/off operation

Short press the " " button to turn on, and enter the real-time interface after booting up the full screen for 2s; after booting, press the button for a long time for 1s, and then the instrument shuts off.

2. Data hold

In the real-time interface or difference interface, short press the " " button to switch to the Hold interface, and the top of the screen will display "H"; Press the button again in the hold interface to return to the interface before entering the hold interface. In the real-time interface, long press the " " button to calibrate the zero point.

3. Sound alarm on/off settings

Under the real-time interface, long press " " button to display " " ; turn on an audible alarm. Long press the button again to close.

4. Measurement mode switching

In the real-time interface, short press the " " button to switch the measurement mode; Mode: Normal - Difference (Δ) - Maximum (MAX) - Minimum (MIN) - Integral Value (Σ) - Integral Average (AVG), long press to return to normal mode.

5. Illuminance unit switching

In the real-time interface, short press the " " button to switch the illuminance unit "Lx/Fc"; long press the button to switch the temperature unit "°C/°F".



6. Record data/delete records

In the real-time interface, short press the " " button, and "REC" is displayed in the upper left corner at the top of the screen. When it flicks, it means to record a piece of data. Short press the button again to close, and long press the button to delete the record.

7. Timed shutdown on/off setting

In the real-time interface, short press the " " button, and " " is displayed in the upper right corner at the top of the screen, indicating that the timed shutdown function has been turned on. Short press the button again to turn it off.

8. Bluetooth on/off settings

In the real-time interface, short press the "" button, and "" is displayed at the top of the screen. When it flashes, it indicates that Bluetooth is on; when "" stops flashing, it means Bluetooth is connected; (the first short press after connecting to Bluetooth is to disconnect Bluetooth; the second short press is to turn off Bluetooth).

9. Display

Difference (Δ): the absolute value of the value after the button is pressed minus the previous value.

Maximum value (**MAX**): the maximum value after a short press.

Minimum value (**MIN**): the minimum value after a short press.

Integral (Σ): Calculated by adding the average value of the comparison value within 0.001 hour of unit time together. The maximum value is 999999, which is

Integral average (**AVG**): Integral value/cumulative frequency.

Data hold(**H**): Save the current data.

10. Power-off memory

A. Automatic shutdown function (1min~99min)

B. Bluetooth switch

C. Alarm sound switch

D. Illuminance & Temperature Units (Lx- Fc & °C-°F)

E. Maximum number of records: 32752; Recording interval: 1s~9999s

VI. Parameters

illuminance probe		silicon photodiodes	
Illuminance range		0~200000Lx (0~18581Fc)	
gears	Gear range	resolution	error
1 gear	0~999.9Lx (0~92.894Fc)	0.1 Lx (0.01Fc)	±3%
2 gear	1000~9999Lx (93~929Fc)	1 Lx (0.1Fc)	±4%
3 gear	10000~99999Lx (929~9290Fc)	10 Lx (0.9Fc)	±4%
4 gear	100000~200000Lx (18581Fc)	100 Lx (9.3Fc)	±4%
Temperature range	-10°C~65°C (14°F~149°F)	0.1 °C (32°F)	±1.5°C (35°F)

VII. App operation instructions

1. APP main interface:

- (1) When you enter the homepage and click "" in the upper left corner, a Bluetooth device search box will appear. Click the "Search" button. When the device list searches for the "IlluminationMeter" device name, click the device name, and when the "Connection is successful" prompt appears, it indicates that the connection has been successful. If "Connection failed", you need to click the "Search" button again to search and click the device name again.

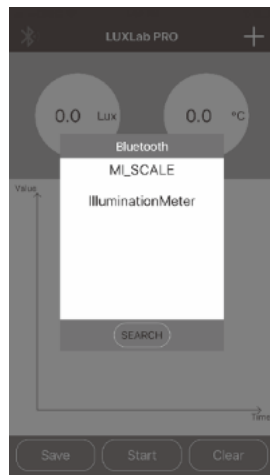

- (2) After the connection is successful, you can click the three buttons at the bottom of the page, namely "Save", "Start" and "Clear". Click the "Start" button to start reading the real-time data of the device and making a line chart show. When you need to stop, just click again. Click the "Save" button to save the real-time data displayed on the current page. When you name the data to be saved, you can view the saved data in the "folder". Click the "Clear" button to clear the real-time data read before and the current data displayed by the line graph.

- (3) If you need to check other functions, just click the settings button in the upper right corner. A dropdown menu with "Setting" "Folder" options will appear (click "Setting", you will enter the setting page, you can set other aspects of the device; click "Folder", you will enter the page of historical data, and you can view real-time data and a history list for storage data preservation)

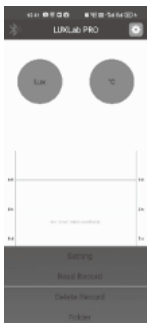

Android main interface:

Click , "Settings" "Folder" option will pop up.

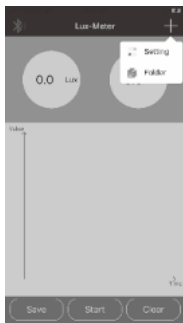

iOS main interface:

Click , the pop-up window "Settings" "Folder" option.

2. Setup page:

The settings page is divided into two sections: setting content and setting alarm values.

(1) Set content

- @When you need to shut down at scheduled time, you can set the time after turning on the back switch, then click the "Save Storage Settings" button to complete the setting.
- @The number of stored data: Shows the number of data already stored in the device. "Occupied" after that is the percentage of total space occupied.
- @When you need to set the interval of the storage time, again, after setting the time, just click the "Save Storage Settings" button.
- @ If you need the device to store data, you can start storing by turning on the "Storage Switch" and then clicking the "Save Storage Settings" button. If you want to stop storing, you need to turn off the "Storage Switch" and click the "Storage Settings" button again.

- @ The "Clear Stored Data" button clears the data stored on the device, and the data originally stored on the device will be emptied.
 - @ The purpose of the "Read stored data" button is to read the data stored on the device and save it to the phone for viewing.
 - @ The "Save settings" button is an operation to save the scheduled shutdown time, the scheduled shutdown state, the storage time interval, and whether the switch state to be saved is required. In order to prevent accidental touch, when the memory switch is turned on, the "Data Read" button cannot be clicked, and the data can be read only after the memory switch is turned off.
- (2) Set alarm values
- @ Measurement interval, is the measurement interval set for reading real-time data from the device.
 - @ Set the high and low alarm value, is a self-setting of the device's high and low alarm value. The default high alarm value is 10,000, and the maximum set limit is 200000. The default value for low alarms is 0. After the setting is completed, you need to click the "Save Alarm Setting" button to save the set high and low alarm values.
 - @ Alarm switch: Enable/disable the alarm function of the device @ "Save alarm settings" button is for the purpose of saving high and low alarm values.



Android settings interface



iOS settings interface

3. Historical data page

- (1) The currently saved data has been classified and distinguished. For the real-time data stored on the home page, the word "real time" will be displayed on the right side of the data list. If the data stored by the device is read on the setting page, the word "storage" will be displayed on the right side. The left side will display the date, date, and file name of the file accordingly.
- (2) Click the "Delete more" button in the upper right corner of the page, and a pair of check items will appear in front of each saved data. After the check, click the "Delete" button in the upper left corner of the page to delete multiple data at the same time.
- (3) The "Share" and "Delete" options will appear on the slide for each data group;
 - @ "Share" option, the current data will be shared with a third party. After sharing, it can be viewed in an Excel table.
 - @ "Delete" option, the current data will be deleted individually, and no multiple files will be deleted.

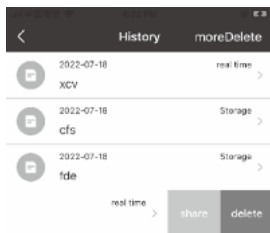

4. On the data details page, the saved data is displayed in a list, which is convenient for users to view. The upper right corner of @ shows the number of data stored in the current data group.
 - @ In the first line, when in "Save" mode, the serial number is displayed. In the "real-time" mode, the time displayed is the real-time display time.
 - @ The second line is the numerical value of illuminance. What follows is the unit at the time of saving. If the unit is changed during use, it will also be displayed here.
 - @ The third line is the temperature value/pattern (Note: The "temperature value" is displayed in real time, "Mode" is displayed in storage state).

<	Data List	loadNum:41
recording Time	illuminance	Temperature
14:44:33	36.6 Lux	26.1 °C
14:44:34	36.7 Lux	26.2 °C
14:44:35	36.9 Lux	26.0 °C
14:44:36	37.8 Lux	26.1 °C
14:44:37	37.4 Lux	26.0 °C
14:44:38	29.8 Lux	26.1 °C
14:44:39	37.6 Lux	26.1 °C
14:44:40	23.0 Lux	26.1 °C
14:44:41	37.9 Lux	26.1 °C
14:44:42	28.1 Lux	26.0 °C
14:44:43	39.7 Lux	26.1 °C
14:44:44	14.6 Lux	26.0 °C
14:44:45	38.6 Lux	26.1 °C
14:44:46	39.0 Lux	26.1 °C

VIII. Connection between host and PC

1. Instructions for use

- (1) Computer configuration: Operating memory (RAM): 4G or above; Main frequency: 3G or above; 64-bit W IN7/W IN10/W IN11.
- (2) For the serial communication method, you need to select a port. When using real-time measurement, make sure that the product is connected to the computer (that is, "connected" is displayed in the lower left corner; if "ready" is displayed, the product is not connected).

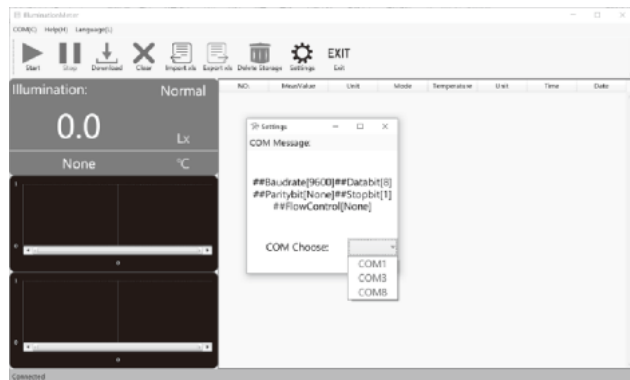

- (3) When the icon is gray, it means that it cannot be operated currently.
- (4) One computer can open multiple ILLUM inat ionMeter apps at the same time.

2. Menu bar

(1) Documents

Press "A It+F+Up/Down" to switch: Open - Save As - Close File - Exit, and press "Enter" to select; Or mouse operation. (as shown in Figure 1)

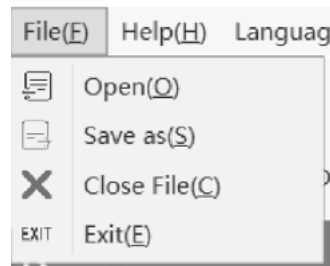

(Figure 1)

(2) Help

Press "A It + H + up/down" to switch: about-help, press "Enter" to select; Or mouse operation. (as shown in Figure 2)

(4) Language switching

Press "A It+ L+Up/Down" to switch: Simplified Chinese - English, press "Enter" to select; or use the mouse. (as shown in Figure 3)



(Figure 2)

(Figure 3)

3. Key bar

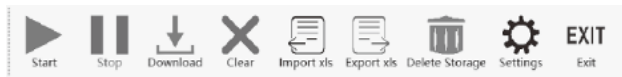

- (1) Start: After the product is connected to the computer, click "Start" to measure and synchronize the data to the computer in real time;
- (2) Stop: To end real-time measurement, press this button to stop data transmission;
- (3) Download: Used to download data saved on the product when not connected to a computer. If the product does not save data, "No storage" is displayed (Figure 4-1); for saved data, clicking "Download" will be displayed in the "Documents" column.



(Figure 4-1)

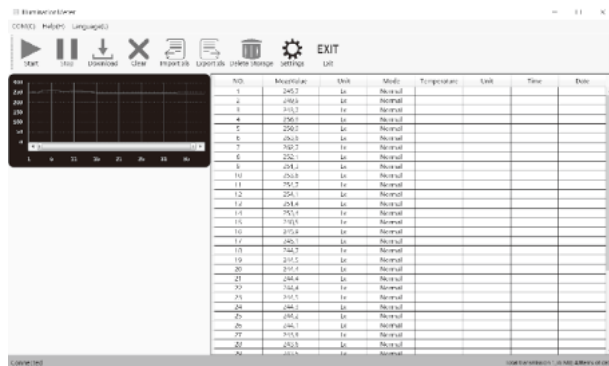

(Figure 4-2)

- (4) Clear: Clear recorded data;
- (5) Input xls: only .xls files can be entered;
- (6) Output xls: output only .xls file, the output path can be customized, and the output file can be opened with EXCEL;
- (7) Delete storage: Delete all stored data from the meter.
- (8) Setting: Read the instrument setting information and enter the setting page, if there is no update setting data, please click again.
- (9) Exit: Close the software.

4. Measurement display

When starting the measurement, click the "Start" button to record data in real time (as shown in Figure 5); click the "Stop" button to end the measurement;

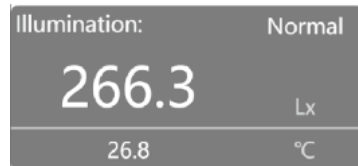

(Figure 5)

5. Line chart

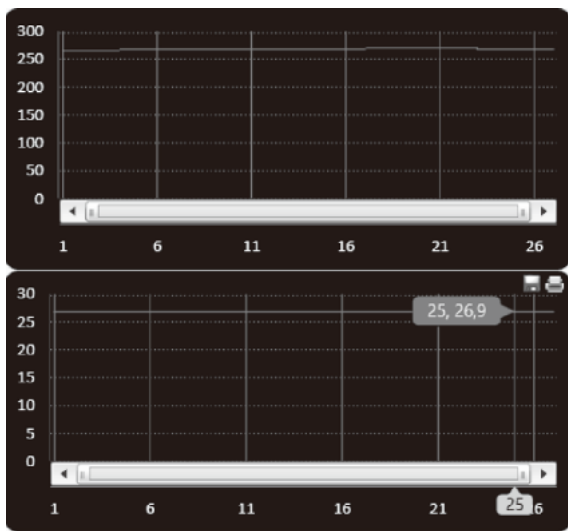

(Picture above image below)

- (1) The X-axis is the sampling data serial number, the upper figure on the y-axis is the illuminance value, and the lower figure is the temperature value;
- (2) The illuminance unit and temperature unit are consistent with the product selection unit during real-time measurement;
- (3) When the mouse moves to the interface, the "Save" and "Print" icons appear in the upper right corner. Slide the mouse wheel (middle key) to zoom in or out.

6. Tabular interface

- (1) The illuminance value, illuminance unit, mode, temperature value, temperature unit, computer time, and computer date in the table will be updated each time the data is transmitted.
- (2) Time and date refers to the current computer time date.
- (3) You can drag the mouse to change the column width.
- (4) To save table data, click "Output" in the button bar, select the save path, and name the file.

NO.	Meas/value	Unit	Mode	Temperature	Unit	Time	Date
3	264.9	Lx	Normal	26.9	°C	16:24:58	07/06/2022
4	265.9	Lx	Normal	26.9	°C	16:24:59	07/06/2022
5	262.2	Lx	Normal	26.9	°C	16:25:00	07/06/2022
6	262.1	Lx	Normal	26.9	°C	16:25:01	07/06/2022
7	262.2	Lx	Normal	26.9	°C	16:25:02	07/06/2022
8	262.4	Lx	Normal	26.9	°C	16:25:03	07/06/2022
9	262.3	Lx	Normal	26.9	°C	16:25:04	07/06/2022
10	261.8	Lx	Normal	26.9	°C	16:25:05	07/06/2022
11	261.3	Lx	Normal	26.9	°C	16:25:06	07/06/2022
12	261.4	Lx	Normal	26.9	°C	16:25:07	07/06/2022
13	262.3	Lx	Normal	26.9	°C	16:25:08	07/06/2022
14	266.1	Lx	Normal	26.9	°C	16:25:09	07/06/2022
15	268.1	Lx	Normal	26.9	°C	16:25:10	07/06/2022
16	268.3	Lx	Normal	26.9	°C	16:25:11	07/06/2022
17	269.7	Lx	Normal	26.9	°C	16:25:12	07/06/2022
18	265.9	Lx	Normal	26.9	°C	16:25:13	07/06/2022
19	260.1	Lx	Normal	26.9	°C	16:25:14	07/06/2022
20	259.0	Lx	Normal	26.9	°C	16:25:15	07/06/2022
21	262.5	Lx	Normal	26.9	°C	16:25:16	07/06/2022
22	259.1	Lx	Normal	26.9	°C	16:25:17	07/06/2022
23	255.6	Lx	Normal	26.9	°C	16:25:18	07/06/2022
24	256.5	Lx	Normal	26.9	°C	16:25:19	07/06/2022
25	260.2	Lx	Normal	26.8	°C	16:25:20	07/06/2022
26	262.1	Lx	Normal	26.9	°C	16:25:21	07/06/2022
27	263.4	Lx	Normal	26.9	°C	16:25:22	07/06/2022
28	263.3	Lx	Normal	26.9	°C	16:25:23	07/06/2022
29	263.3	Lx	Normal	26.9	°C	16:25:24	07/06/2022
30	263.4	Lx	Normal	26.9	°C	16:25:25	07/06/2022

7. Setup interface:

- (1) The automatic shutdown requires a check before setting the value. The range is 1 to 99 minutes. Click "上一步" to save the settings to the instrument.
- (2) Total number of stored data is 32,752, recording time = recording time interval (range 1 to 999 seconds) * Record the number of strokes. Turn on the recording switch, and when the settings are complete, click Upload to save to the instrument.
- (3) Online measurement time interval: range 1~999 seconds, no need to click upload.

- (4) Set the alarm value in the range of 0.0-200000, regardless of the unit. Turn on the switch and click Upload to save settings to the meter.
- (5) For the above box of setting values, you need to delete the value operation before entering a new setting value. Otherwise, the error message will overflow.

Settings

AutoShutdown(m)

StoredAmount: 40 Occu0,1%

StorageInterval(s)

StorageSwitch:  Upload

MeasureInterval(s)

SetHighAlarm:

SetLowAlarm:

AlarmSwitch:  Upload

8. Status bar

*Connection status with the product

(1) Unconnected products:

Connected

(2) Connected products:

Disconnected