

A

B

C

D

E



MODEL: GT5105A

Digital Earth Resistance Tester Instruction manual



Standard: Q/GMY 009-2017
Version: 5105A-EN-00

7164105002 GT5105A英文有唛说明书

材质: 105G双铜;

成品尺寸: 95*133mm

公差: +-1.0mm;

页数: 16P; 双面单色印刷;

工艺: 装订成册说明书; 加工: 骑马钉

3.		
2.		
1.		
次号	更改内容	日期
	更改记录	

APPROVALS	NAME	DATE
DRAWN BY	GAP	2020.04.20
CHECKED BY		
APP. BY		
CUSTOMER		

SHENZHEN JUMAOYUAN SCIENCE AND TECHNOLOGY CO.,		
GT5105A (BENETECH) 英文有唛说明书示意图		
SIZE A4	7164105002	
SCALE	PART Number:	SHEET 1 OF 1

A

B

C

D

E

CONTENTS

1. Notice before use

- Check-up------(01)
- Introduction and function -----(02)
- Description of main product components -(03)
- Screen display instruction -----(04)
- Technical specifications ----- (05)

2. Operation Instructions

- Preparation before measurement------(06)
- Safety warning------(07)
- Measurement method------(10)

3. Other items

- Maintenance and warranty -----(13)

1. Notice before use

Check-up

Carefully unpack your kit and ensure that you have the following items. In case that any items is missing or if you find any mismatch or damage, promptly contact your dealer.

- Digital Earth Resistance Tester-----1pcs
- 5 meters of green test lead (with alligator clip) -----1pcs
- 10 meters of yellow test lead (with alligator clip) --1pcs
- 20 meters of red test lead (with alligator clip) -----1pcs
- Auxiliary ground nail----- 2pcs
- No.5 alkaline battery----- 6pcs
- User's manual-----1pcs
- Strap / Leather Case-----1pcs
- Cloth bag-----1pcs

Introduction

This instrument is controlled by intelligent microcontroller chip, with high accuracy and high reliability; it can be used to measure grounding resistance of various power facilities wiring, electrical equipment, lightning protection equipment and other grounding devices, and it can also measure ground voltage. (Note: This instrument is not suitable for harsh outdoor environmental conditions, such as raining, lightning, etc.)

Functions

- backlight and battery detection function.
- data holding.
- It can be used for precise three-wire measurement or simple two-wire measurement.
- When measuring ground resistance, if C or E end of test lead is not in good contact, "---- Ω" warning appears on LCD.
- "OL" stands for over range.
- Double insulation or reinforced insulation safety structure.

-02-

Name of parts(Figure 1)

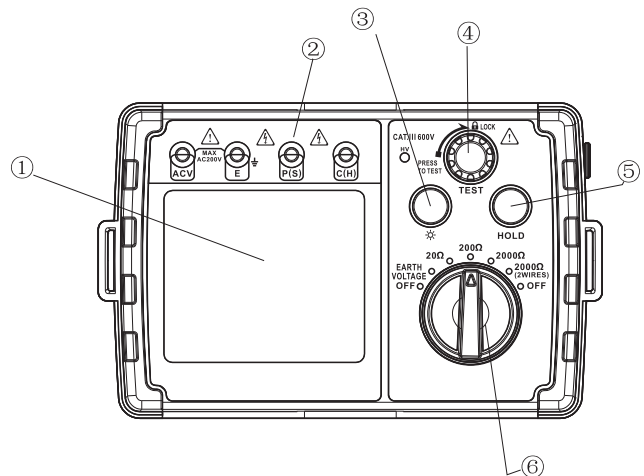

-03-

1. LCD
2. Test lead connection port.
3. LIGHT
4. TEST button
5. HOLD
6. Function selection switch

LCD Displays(Figure2)

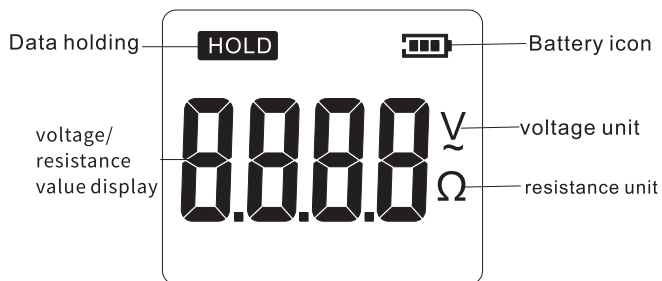

Figure2

Specifications

1.1 Measurement range and measurement error (under condition of $20^{\circ}\text{C} \pm 5^{\circ}\text{C}$ and $\leq 75\% \text{RH}$)

Basic Function	Range	Accuracy	Resolution
Ground resistance	20 Ω	$\pm(2\%+10)$	0.01 Ω
	200 Ω	$\pm(2\%+3)$	0.1 Ω
	2000 Ω	$\pm(2\%+3)$	1 Ω
	2000 Ω (two wires)	$\pm(2\%+5)$	1 Ω
Ground voltage	200V	$\pm(2\%+5)$	0.1V

auxiliary grounding resistance 500 Ω ; Error + 5%;
Grounding voltage $\leq 10\text{V AC}$

1.2 Application standard:
IEC 61010-1 CAT. III 600V Pollution degree 2
CAT. I 5000V Pollution degree 2
IEC 61326-1 (EMC standard)
IEC 60529 (IP40)

1.3 measurement method:

- (1) Ground voltage measurement: average response
- (2) Ground resistance measurement: test signal frequency: about 820Hz, current: 20 Ω about 3.2mA

1.4 Working environment: temperature: $5^{\circ}\text{C} \sim 40^{\circ}\text{C}$; relative humidity: $\leq 80\% \text{RH}$ (no fog) Altitude ≤ 2000 meters

1.5 Storage conditions: temperature: $-20 \sim 60^{\circ}\text{C}$; relative humidity: $\leq 70\% \text{RH}$ (no fog)

1.6 Power supply: 9V power supply [1.5V (No. 5 alkaline battery) * 6]

1.7 Overload protection:

Ground resistance: 200V AC (10 seconds)

Ground voltage: 400V AC (30 seconds)

1.8 Insulation resistance: The insulation resistance between measurement circuit and case is not less than 20MΩ

1.9 Dimensions: 176mm * 77mm * 110mm

2. Operation manual

Preparation before measurement

2.1. Check the battery voltage & battery replacement:

Set function selection switch at ground voltage or ground resistance gear; if "⎓" appears on the LCD, it indicates that battery power is low, and batteries need to be replaced, otherwise the instrument cannot be used normally.

Battery icon	Battery voltage
⎓	>8.45V
⎓	>7.72V
⎓	>7V
⎓	≤7V

2.2 Test lead connection

Please make sure that the test lead plug is fully inserted into test end before measurement. A loose connection may affect accuracy of measurement value.

Safety warning

⚠ WARNING

Electricity - is dangerous, and can cause personal injury or death, in order to enable you to use the equipment correctly and safely, please read the warning message and safety regulations in this manual carefully before use and strictly comply with them.

The safety symbol "⚠" has three implications in this manual. Users should pay special attention to operation with "⚠" symbol during reading.

- ⚠ **DANGER**—indicates that an environment and operation is likely to cause serious or fatal injury.
- ⚠ **WARNING**—Indicates that an environment and operation can cause serious or fatal injury.
- ⚠ **CAUTION**—Indicates that environment and operation can cause limited injury or damage to the instrument.

△ DANGER

- Do not measure in the flammable and explosive environment, or sparks may be generated during use, which may cause an explosion.
- Do not make any measurements while the instrument or your hands are still wet.
- Do not exceed the maximum allowable range when measuring.
- Do not open the battery cover while measuring.
- Do not touch any exposed wires during the test.
- Be sure to turn the test knob back to the OFF position after measurement.





△ WARNING

- The instrument must be operated by a trained and qualified technician and used under the conditions specified in the manual.
- Please do not open the housing during the test, if there is a failure, please refer to the professional staff for inspection and maintenance.
- Do not replace the battery when the instrument is wet.
- Make sure all test wires are securely connected to the test port of the instrument.
- Make sure the device is switched off before opening the battery cover.
- Please check your instrument frequently. If there is any abnormal phenomenon (broken wire/cracked casing, etc.), please do not do any operation.
- Please do not replace parts or make any modifications to the instrument. Please contact the dealer who sells the product for repair.

△ CAUTION

- Before measurement, make sure the range switch is switched to the appropriate position.
- After use, place the measuring selection button in the "OFF" position. If it is not used for a long time, please take out the battery to avoid leakage and damage to the instrument.
- When the instrument is wet, please dry it before storage.
- Please do not store the instrument under high temperature, high humidity or direct sunlight.
- Please use soft cloth with a small amount of water or neutral detergent to clean the instrument shell, do not use friction material or solvent.

Implication of relevant icons of this instrument:

	AC		DC
	Grounding		There may be danger of electric shock
	The instrument has double insulation or reinforced insulation		

Measurement method

caveat

When the instrument performs ground resistance function test, a maximum voltage of about 50V~ will be generated between E-C end s. Do not touch the exposed metal part of test lead and auxiliary ground nail to avoid electric shock.

3.1 Accurate measurement (tested with standard test lead):

- a. pound P and C ground nails deeply into the ground, line them and equipment to be measured in a line (straight line) with distance 5 to 10 meters. The connection method is shown in Figure 2:
(Note: Make sure ground nail is pressed in wet soil. If the soil is dry, add enough water; stone or sand must also be wet before testing. If it is difficult to make auxiliary ground piles in concrete areas of urban areas, you can lay two steel plates of 25cm*25cm (or use existing auxiliary ground nails) flat on the concrete floor and apply wet towel, pour enough water to replace measuring electrode. Generally, the measurement can be performed.)
- b. Ground voltage test: The function selection switch is screwed to the ground voltage range, and LCD displays ground voltage measurement. Status: Insert test leads into V and E ends (do not insert test leads into other test ends) and then connect to the test point, LCD will display measured value of ground voltage (note: do not press TEST button when measuring the ground voltage), if measured value is > 10V, turn off relevant electrical equipment, and perform ground resistance test after ground voltage declines, otherwise it will affect test accuracy of ground resistance.

-10-

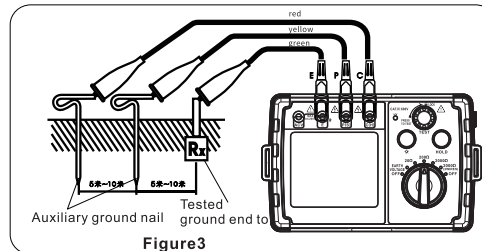

C:Auxiliary electrode
P: Point electrode
E:tested electrical end

caveat

Ground voltage test is only performed on the V and E ends, and the connection between C and P ends must be disconnected, otherwise it may cause danger or damage to the instrument.

- c. Ground resistance test: Rotate function selection switch to 2000Ω (maximum gear), and press "TEST" button, with LCD displaying ground resistance value. If the measured resistance value is less than 200Ω, turn function selection switch to the connection. 20Ω gear of ground resistance is, and LCD displays ground resistance value. You can also measure in the order of other gears. Be sure to select suitable gear to measure to make sure the measured value the most accurate. When you press "TEST" button, status indicator on the button will light up, indicating that the instrument is under test state.
(Note: if test lead of C or E end have poor contact, auxiliary ground resistance or ground resistance is too large (such as more than 32KΩ for 20Ω gear), or the test terminal is open, LCD will display "---- Ω". At this time, please check whether line connection is good, the soil is too dry, and the auxiliary grounding nail is reliably grounded.)
When the measured ground resistance is greater than measurement range of this gear, that is, more than 32KΩ for 20Ω gear or more than 43KΩ for 200Ω gear or more than 65KΩ for 2000Ω, the LCD will display "OL" (over range). Note: If auxiliary ground nail used by this instrument is bent or touches other things, the reading will be affected. When connecting test lead, be sure to clean auxiliary ground nail first. If the resistance of the auxiliary ground nail is too large, it will cause reading errors.

-11-

d. Data hold function

When measuring, press the HOLD key to hold the current data and display the HOLD symbol. Press the HOLD key again to cancel the data hold function.

e. Backlight

Press the backlight button, the screen backlight light is on, press the backlight button again, the screen backlight light is off.

3.2 Simple measurement (measured with provided simple test line):

By this method, if it is not convenient to use auxiliary ground nail, exposed low ground resistance can be used as electrode, such as metal sink, water pipe, common ground of power supply line, ground terminal of building, All the above can use 2-wire method (E and P & C ends). The wiring is shown in Figure 4:

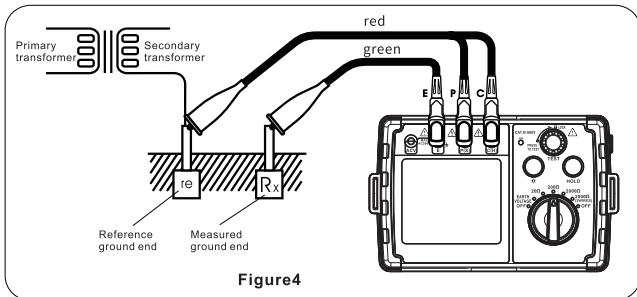

Figure4

When this method is applied, P and C end are actually shorted together.

⚠ DANGER

When taking ground point of commercial power system as reference point test, please be careful of electrical hazard.

3. Other items

Maintenance and warranty

4.1 Maintenance

4.1.1 Battery replacement and maintenance

(Please refer to Figure 5) If low voltage indicator appears, replace batteries in time as following steps;

- a. Turn off the instrument and remove relevant test leads.
- b. Unscrew one screw at the bottom of battery door, and then open the door
- c. Please replace all six used batteries, put in new batteries, and pay attention to polarity of batteries.
- d. After replacing batteries, please install battery door and tighten screws.

When the instrument is not used for a long time, please remove batteries to prevent battery leakage and corrosion of battery case and pole pieces.

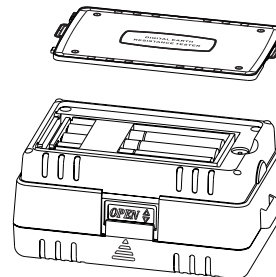

Figure5

4.1.2 Case cleaning

Alcohol, diluent, etc. have a corrosive effect on instrument case, especially the window; so when cleaning instrument case, wipe it gently with wet towel.

4.1.3 Please prevent the instrument from getting wet.

4.2 Maintenance

4.2.1 If you have any following questions, please contact after-sales service department of our company's marketing department or agencies:

- A. Instrument components are damaged.**
- B. LCD is abnormal.**
- C. In normal use, the error is too large.**
- D. Button operation failure or confusion.**

4.2.2 If it is necessary to repair the instrument, please send the instrument to a qualified professional maintenance personnel or designated maintenance department.

Special statement:

- a. Used batteries must be disposed of in accordance with local laws or regulations**
- b. The company is not liable for any derivative results of using this product.**
- c. The company reserves the right to update and modify the design specifications and content of this product, and it is subject to change without notice!**