



**SDS Series**  
**Smart Digital Storage Oscilloscopes**  
**User Manual**

■ **SDS6062(V)**

■ **SDS7072(V)**

■ **SDS7102(V)**

■ **SDS7202(V)**

■ **SDS8102(V)**

■ **SDS8202(V)**

■ **SDS8302**

■ **SDS9302**

**Note:** "V" for VGA interface (optional);

SDS8302 and SDS9302 including VGA interface as default.

[www.owon.com.cn](http://www.owon.com.cn)

## **Nov. 2017 edition V1.7.4**

Copyright © LILLIPUT Company. All rights reserved.

The LILLIPUT's products are under the protection of the patent rights, including ones which have already obtained the patent rights and those which are applied for. The information in this manual will replace all materials published.

The information in this manual was correct at the time of printing. However, LILLIPUT will continue to improve products and reserves the rights to change specification at any time without notice.

**owon**<sup>®</sup> is the registered trademark of the LILLIPUT Company.

### **Fujian LILLIPUT Optoelectronics Technology Co., Ltd.**

No. 19, Heming Road

Lantian Industrial Zone, Zhangzhou 363005 P.R. China

**Tel:** +86-596-2130430

**Fax:** +86-596-2109272

**Web:** [www.owon.com.cn](http://www.owon.com.cn)

**E-mail:** [info@owon.com.cn](mailto:info@owon.com.cn)

# General Warranty

OWON warrants that the product will be free from defects in materials and workmanship for a period of 3 years from the date of purchase of the product by the original purchaser from the OWON Company. The warranty period of accessories such as probe, battery is 12 months. This warranty only applies to the original purchaser and is not transferable to the third party.

If the product proves defective during the warranty period, OWON either will repair the defective product without charge for parts and labor, or will provide a replacement in exchange for the defective product. Parts, modules and replacement products used by OWON for warranty work may be new or reconditioned like new performance. All replaced parts, modules and products become the property of OWON.

In order to obtain service under this warranty, customer must notify OWON of the defect before the expiration of the warranty period. Customer shall be responsible for packaging and shipping the defective product to the service center designated by OWON, and with a copy of customer proof of purchase.

This warranty shall not apply to any defect, failure or damage caused by improper use or improper or inadequate maintenance and care. OWON shall not be obligated to furnish service under this warranty a) to repair damage resulting from attempts by personnel other than OWON representatives to install, repair or service the product; b) to repair damage resulting from improper use or connection to incompatible equipment; c) to repair any damage or malfunction caused by the use of non-OWON supplies; or d) to service a product that has been modified or integrated with other products when the effect of such modification or integration increases the time or difficulty of servicing the product.

Please contact the nearest OWON's Sales and Service Offices for services or a complete copy of the warranty statement.

For better after-sales service, please visit [www.owon.com.cn](http://www.owon.com.cn) and register the purchased product online.

**Excepting the after-sales services provided in this summary or the applicable warranty statements, OWON will not offer any guarantee for maintenance definitely declared or hinted, including but not limited to the implied guarantee for marketability and special-purpose acceptability. OWON should not take any responsibilities for any indirect, special or consequent damages.**

# Table of Contents

<b>1. General Safety Requirements</b> .....	<b>1</b>
<b>2. Safety Terms and Symbols</b> .....	<b>2</b>
<b>3. General Characteristics</b> .....	<b>4</b>
<b>4. Junior User Guidebook</b> .....	<b>5</b>
<b>Introduction to the Structure of the Oscilloscope</b> .....	<b>6</b>
Front Panel .....	6
Left Side Panel .....	7
Right Side Panel .....	7
Rear Panel .....	8
Control (key and knob) Area .....	9
<b>User Interface Introduction</b> .....	<b>10</b>
<b>How to Implement the General Inspection</b> .....	<b>12</b>
<b>How to Implement the Function Inspection</b> .....	<b>12</b>
<b>How to Implement the Probe Compensation</b> .....	<b>13</b>
<b>How to Set the Probe Attenuation Coefficient</b> .....	<b>14</b>
<b>How to Use the Probe Safely</b> .....	<b>15</b>
<b>How to Implement Self-calibration</b> .....	<b>15</b>
<b>Introduction to the Vertical System</b> .....	<b>16</b>
<b>Introduction to the Horizontal System</b> .....	<b>17</b>
<b>Introduction to the Trigger System</b> .....	<b>18</b>
<b>5. Advanced User Guidebook</b> .....	<b>19</b>
<b>How to Set the Vertical System</b> .....	<b>20</b>
<b>Use Mathematical Manipulation Function</b> .....	<b>26</b>
Using FFT function .....	28
Digital Filter (Only for some models) .....	32
<b>Use VERTICAL POSITION and VOLTS/DIV Knobs</b> .....	<b>32</b>
<b>How to Set the Horizontal System</b> .....	<b>33</b>
<b>How to Set the Trigger System</b> .....	<b>36</b>
Single trigger .....	36
Alternate trigger .....	40
<b>How to Operate the Function Menu</b> .....	<b>44</b>
How to Implement Sampling Setup .....	44
How to Set the Display System .....	46
How to Save and Recall a Waveform.....	50

How to Cut and Recall a waveform .....	57
How to Record/Playback Waveforms .....	60
How to Implement the Auxiliary System Function Setting.....	65
How to Measure Automatically.....	72
How to Measure with Cursors.....	75
How to Use Autoscale.....	80
How to Use Built-in Help.....	82
How to Use Executive Buttons.....	82
<b>6. Communication with PC.....</b>	<b>84</b>
<b>Using USB Port.....</b>	<b>84</b>
<b>Using LAN Port .....</b>	<b>85</b>
Connect directly .....	85
Connect through a router.....	86
<b>Using COM Port.....</b>	<b>88</b>
<b>7. Demonstration .....</b>	<b>89</b>
<b>Example 1: Measurement a Simple Signal.....</b>	<b>89</b>
<b>Example 2: Gain of a Amplifier in a Metering Circuit.....</b>	<b>90</b>
<b>Example 3: Capturing a Single Signal.....</b>	<b>91</b>
<b>Example 4: Analyze the Details of a Signal.....</b>	<b>93</b>
<b>Example 5: Application of X-Y Function.....</b>	<b>94</b>
<b>Example 6: Video Signal Trigger .....</b>	<b>96</b>
<b>8. Troubleshooting.....</b>	<b>97</b>
<b>9. Technical Specifications.....</b>	<b>98</b>
General Technical Specifications .....	103
<b>10. Appendix .....</b>	<b>104</b>
<b>Appendix A: Enclosure .....</b>	<b>104</b>
<b>Appendix B: General Care and Cleaning .....</b>	<b>104</b>
<b>Appendix C: Battery Using Guide.....</b>	<b>105</b>

# 1. General Safety Requirements

**Before use, please read the following safety precautions to avoid any possible bodily injury and to prevent this product or any other connected products from damage. In order to avoid any contingent danger, ensure this product is only used within the range specified.**

Only the qualified technicians can implement the maintenance.

**To avoid Fire or Personal Injury:**

- **Connect the probe correctly. The grounding end of the probe corresponds to the grounding phase. Please don't connect the grounding end to the positive phase.**
- **Use Proper Power Cord.** Use only the power cord supplied with the product and certified to use in your country.
- **Connect or Disconnect Correctly.** When the probe or test lead is connected to a voltage source, please do not connect and disconnect the probe or test lead at random.
- **Product Grounded.** This instrument is grounded through the power cord grounding conductor. To avoid electric shock, the grounding conductor must be grounded. The product must be grounded properly before any connection with its input or output terminal.

**When powered by AC power, it is not allowed to measure AC power source directly, because the testing ground and power cord ground conductor are connected together, otherwise, it will cause short circuit.**

**When powered by battery, the product must ground connection. To avoid electric shock, there must be a ground wire connect between ground and the ground port (on the back of product panel).**

- **Check all Terminal Ratings.** To avoid fire or shock hazard, check all ratings and markers of this product. Refer to the user's manual for more information about ratings before connecting to the instrument.
- **Do not operate without covers.** Do not operate the instrument with covers or panels removed.
- **Use Proper Fuse.** Use only the specified type and rating fuse for this instrument.
- **Avoid exposed circuit.** Do not touch exposed junctions and components when the instrument is powered.
- **Do not operate if in any doubt.** If you suspect damage occurs to the instrument, have it inspected by qualified service personnel before further operations.
- **Use your Oscilloscope in a well-ventilated area.** Make sure the instrument installed with proper ventilation, refer to the user manual for more details.
- **Do not operate in wet conditions.**
- **Do not operate in an explosive atmosphere.**
- **Keep product surfaces clean and dry.**

## 2. Safety Terms and Symbols

### Safety Terms

**Terms in this manual.** The following terms may appear in this manual:

 **Warning:** Warning indicates the conditions or practices that could result in injury or loss of life.

 **Caution:** Caution indicates the conditions or practices that could result in damage to this product or other property.

**Terms on the product.** The following terms may appear on this product:

**Danger:** It indicates an injury or hazard may immediately happen.

**Warning:** It indicates an injury or hazard may be accessible potentially.

**Caution:** It indicates a potential damage to the instrument or other property might occur.

### Safety Symbols

**Symbols on the product.** The following symbol may appear on the product:

 Hazardous Voltage

 Refer to Manual

 Protective Earth Terminal

 Chassis Ground

 Test Ground

To avoid body damage and prevent product and connected equipment damage, carefully read the following safety information before using the test tool. This product can only be used in the specified applications.

 **Warning:**

**The two channels of the oscilloscope are not electrically isolated. The channels should adopt a common ground during measuring. To prevent short circuits, the 2 probe grounds must not be connected to 2 different non-isolated DC levels.**

**⚠ Warning:**

The channels should adopt common basis during measuring. To prevent short circuits, the 2 probe ground must not be connected to 2 different non-isolated DC level.

The diagram of the oscilloscope ground wire connection:

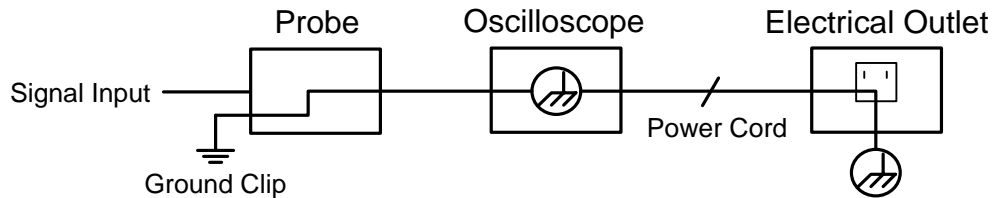

The diagram of the ground wire connection when the battery-powered oscilloscope is connected to the AC-powered PC through the ports:

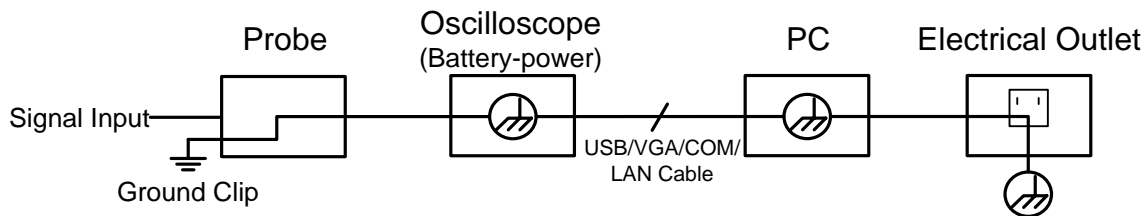

It is not allowed to measure AC power when the oscilloscope is AC powered, or when the battery-powered oscilloscope is connected to the AC-powered PC through the ports.

**⚠ Warning:**

To avoid fire or electrical shock, when the oscilloscope input signal connected is more than 42V peak (30Vrms) or on circuits of more than 4800VA, please take note of below items:

- Only use accessory insulated voltage probes and test lead.
- Check the accessories such as probe before use and replace it if there are any damages.
- Remove probes, test leads and other accessories immediately after use.
- Remove USB cable which connects oscilloscope and computer.
- Do not apply input voltages above the rating of the instrument because the probe tip voltage will directly transmit to the oscilloscope. Use with caution when the probe is set as 1:1.
- Do not use exposed metal BNC or banana plug connectors.
- Do not insert metal objects into connectors.



## 3. General Characteristics

- Bandwidth: 60 MHz - 300 MHz;
- Sample rate(real time): 500 MS/s - 3.2 GS/s;
- Dual channel, 10M points on each channel for the Record length;
- Autoscale function;
- 7cm smart design body;
- 8 inch high definition TFT display (800 x 600 pixels);
- Built-in FFT function;
- Pass/Fail Function;
- Waveform record and playback;
- VGA interface (only for the model with "V" or the models including VGA interface as default);
- Various triggering function;
- USB communication ports;
- Super capacity lithium battery (Optional);
- Built-in Chinese and English help system;
- Multiple language support.

## 4. Junior User Guidebook

**This chapter deals with the following topics mainly:**

- Introduction to the structure of the oscilloscope
- Introduction to the user interface
- How to implement the general inspection
- How to implement the function inspection
- How to make a probe compensation
- How to set the probe attenuation coefficient
- How to use the probe safely
- How to implement an auto-calibration
- Introduction to the vertical system
- Introduction to the horizontal system
- Introduction to the trigger system

## Introduction to the Structure of the Oscilloscope

When you get a new-type oscilloscope, you should get acquainted with its front panel at first and the digital storage oscilloscope is no exception. This chapter makes a simple description of the operation and function of the front panel of the oscilloscope, enabling you to be familiar with the use of the oscilloscope in the shortest time.

### Front Panel

The oscilloscope offers a simple front panel with distinct functions to users for their completing some basic operations, in which the knobs and function pushbuttons are included. The knobs have the functions similar to other oscilloscopes. The 5 buttons (F1 - F5) in the column on the right side of the display screen or in the row under the display screen (H1 - H5) are menu selection buttons, through which, you can set the different options for the current menu. The other pushbuttons are function buttons, through which, you can enter different function menus or obtain a specific function application directly.

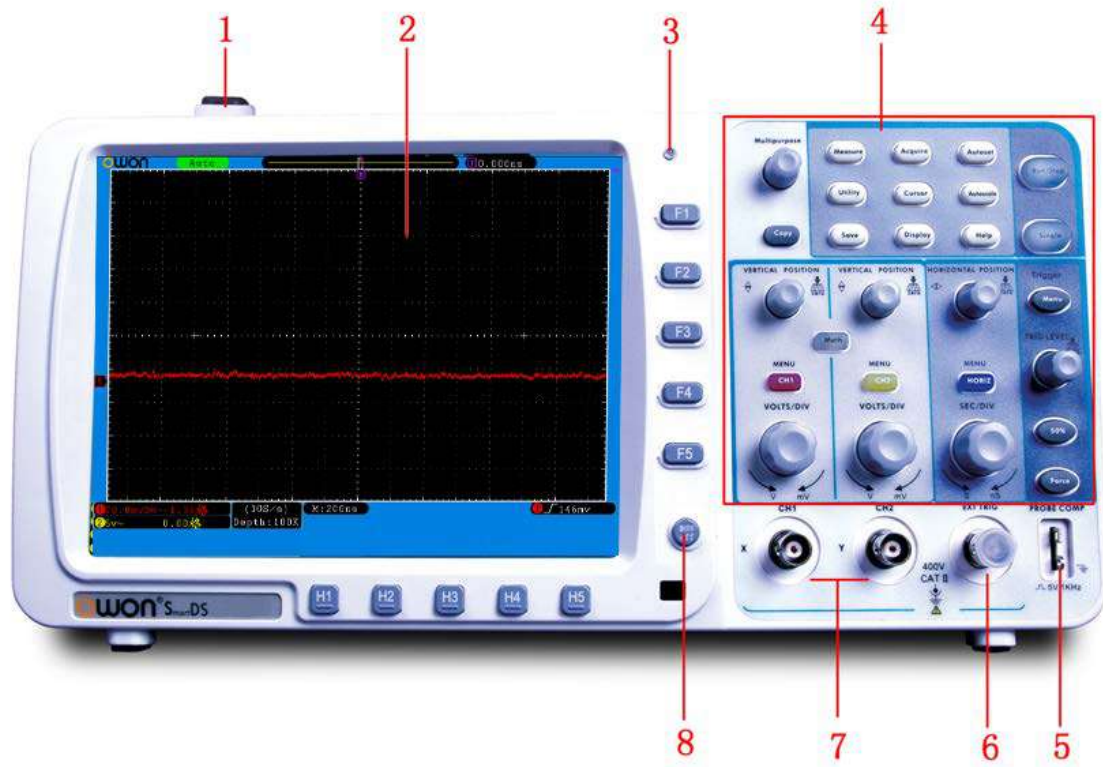

Figure 4-1 Front panel

1. Power on/off
2. Display area
3. Power indication - light

**Green light:** Indicating DSO connects with AC Power, and the battery is in full (if there is battery inside DSO).

**Yellow light:** Indicating DSO connect with AC Power and the battery is in charging (if there is battery inside DSO)

**Light off:** Only powered by battery without connecting AC Power

4. Control (key and knob) area
5. Probe Compensation: Measurement signal (5V/1KHz) output. (The signal parameters could be adjusted in SDS7072(V), refer to "Signal" on P71)
6. EXT Trigger Input
7. Signal Input Channel
8. Menu off

## Left Side Panel



Figure 4-2 Left side panel

1. Power switch: "—" represents power ON; "○" represents power OFF.
2. AC power input jack

## Right Side Panel

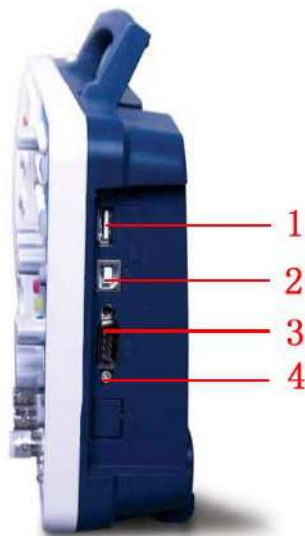

Figure 4-3 Right side panel

1. **USB Host port:** It is used to transfer data when external USB equipment connects to the oscilloscope regarded as "host device". For example: upgrading software by USB flash disk needs to use this port.

2. **USB Device port:** It is used to transfer data when external USB equipment connects to the oscilloscope regarded as "slave device". For example: to use this port when connect PC to the oscilloscope by USB.
3. **COM / VGA port (Optional):** To connect the oscilloscope with external equipment as serial port, or to connect the oscilloscope with a monitor or a projector as VGA output (for the model with "V").
4. **LAN port:** the network port which can be used to connect with PC.

## Rear Panel



Figure 4-4 Rear Panel

1. The port of trigger signal output & Pass/Fail output
2. Handle
3. Air vents
4. Foot stool (which can adjust the tilt angle of the oscilloscope)
5. Ground connection

## Control (key and knob) Area

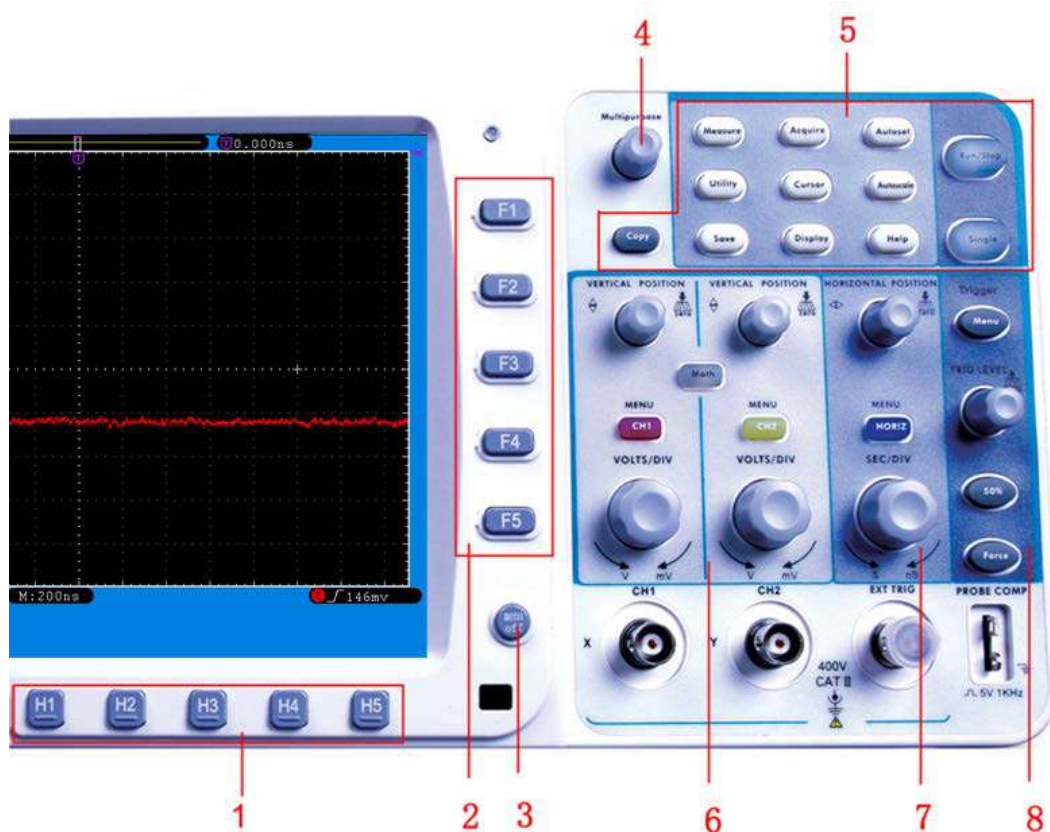

Figure 4-5 Keys Overview

1. Menu option setting: H1 - H5
2. Menu option setting: F1 - F5
3. Menu off: turn off the menu
4. **M** knob(Multipurpose knob): when a **M** symbol appears in the menu, it indicates you can turn the **M** knob to select the menu or set the value. You can press it to close the menu on the left.
5. Function key area: Total 12 keys
6. Vertical control area with 3 keys and 4 knobs.  
 "CH1 MENU" and "CH2 MENU" correspond to setting menu in CH1 and CH2, "Math" key refer to math menu, the math menu consists of six kinds of operations, including CH1-CH2, CH2-CH1, CH1+CH2, CH1\*CH2, CH1/CH2 and FFT. Two "VERTICAL POSITION" knob control the vertical position of CH1/CH2, and two "VOLTS/DIV" knob control voltage scale of CH1, CH2.
7. Horizontal control area with 1 key and 2 knobs.  
 "HORIZONTAL POSITION" knob control trigger position, "SEC/DIV" control time base, "HORIZ MENU" key refer to horizontal system setting menu.
8. Trigger control area with 3 keys and 1 knob.  
 "TRIG LEVEL" knob is to adjust trigger voltage. Other 3 keys refer to trigger system setting.

## User Interface Introduction

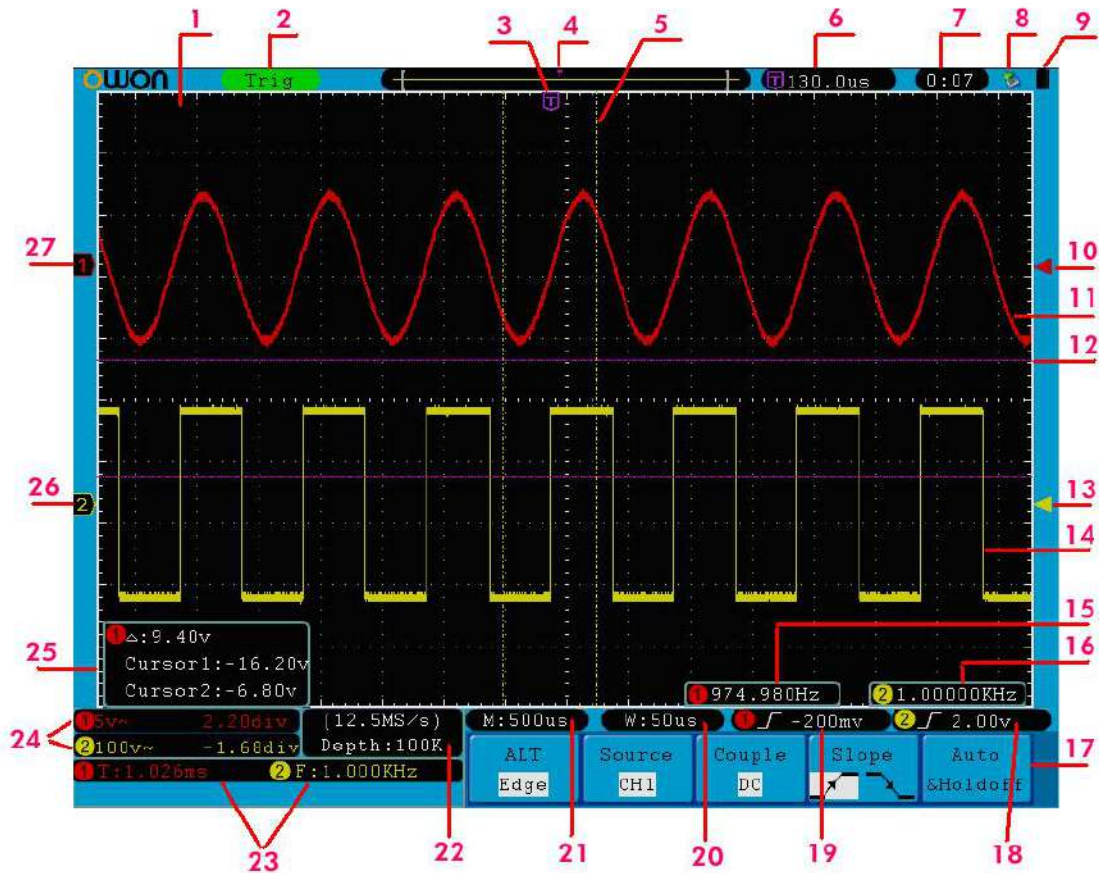





Figure 4-6 Illustrative Drawing of Display Interfaces



1. Waveform Display Area.
2. The state of trigger, including:
  - Auto: Automatic mode and acquire waveform without triggering.
  - Trig: Trigger detected and acquire waveform.
  - Ready: Pre-triggered data captured and ready for a trigger.
  - Scan: Capture and display the waveform continuously.
  - Stop: Data acquisition stopped.
3. The purple T pointer indicates the horizontal position for the trigger.
4. The pointer indicates the trigger position in the internal memory.
5. The two yellow dotted lines indicate the size of the viewing expanded window.
6. It shows present triggering value and displays the site of present window in internal memory.
7. It shows setting time (see "*Config*" on P65 ).
8. It indicates that there is a USB disk connecting with the oscilloscope.
9. Indicating battery power status (see "*Display*" on P66 ).
10. The red pointer shows the trigger level position for CH1.

11. The waveform of CH1.
12. The positions of two purple dotted line cursors measurements.
13. The yellow pointer shows the trigger level position for CH2.
14. The waveform of CH2.
15. The frequency of the trigger signal of CH1.
16. The frequency of the trigger signal of CH2.
17. It indicates the current function menu.

18/19. Current trigger type:

-  Rising edge triggering
-  Falling edge triggering
-  Video line synchronous triggering
-  Video field synchronous triggering

The reading shows the trigger level value of the corresponding channel.

20. The reading shows the window time base value.
21. The reading shows the setting of main time base.
22. The readings show current sample rate and the record length.
23. It indicates the measured type and value of the corresponding channel. "F" means frequency, "T" means cycle, "V" means the average value, "Vp" the peak-peak value, "Vk" the root-mean-square value, "Ma" the maximum amplitude value, "Mi" the minimum amplitude value, "Vt" the Voltage value of the waveform's flat top value, "Vb" the Voltage value of the waveform's flat base, "Va" the amplitude value, "Os" the overshoot value, "Ps" the Preshoot value, "RT" the rise time value, "FT" the fall time value, "PW" the +width value, "NW" the -Width value, "+D" the +Duty value, "-D" the -Duty value, "PD" the Delay A->B  value, "ND" the Delay A->B  value, "TR" the Cycle RMS, "CR" the Cursor RMS, "WP" the Duty cycle, and "RP" the Phase.
24. The readings indicate the corresponding Voltage Division and the Zero Point positions of the channels.

The icon shows the coupling mode of the channel.

"—" indicates direct current coupling

"~" indicates AC coupling

" " indicates GND coupling

25. It is cursor measure window, showing the absolute values and the readings of the two cursors.
26. The yellow pointer shows the grounding datum point (zero point position) of the waveform of the CH2 channel. If the pointer is not displayed, it shows that this channel is not opened.
27. The red pointer indicates the grounding datum point (zero point position) of the waveform of the CH1 channel. If the pointer is not displayed, it shows that the channel is not opened.



## How to Implement the General Inspection

After you get a new oscilloscope, it is recommended that you should make a check on the instrument according to the following steps:

### 1. Check whether there is any damage caused by transportation.

If it is found that the packaging carton or the foamed plastic protection cushion has suffered serious damage, do not throw it away first till the complete device and its accessories succeed in the electrical and mechanical property tests.

### 2. Check the Accessories

The supplied accessories have been already described in the "Appendix A: Enclosure" of this Manual. You can check whether there is any loss of accessories with reference to this description. If it is found that there is any accessory lost or damaged, please get in touch with the distributor of OWON responsible for this service or the OWON's local offices.

### 3. Check the Complete Instrument

If it is found that there is damage to the appearance of the instrument, or the instrument can not work normally, or fails in the performance test, please get in touch with the OWON's distributor responsible for this business or the OWON's local offices. If there is damage to the instrument caused by the transportation, please keep the package. With the transportation department or the OWON's distributor responsible for this business informed about it, a repairing or replacement of the instrument will be arranged by the OWON.

## How to Implement the Function Inspection

Make a fast function check to verify the normal operation of the instrument, according to the following steps:

### 1. Connect the power cord to a power source. Turn on the Power Switch Button on the left side (make sure the "-" side is pressed down). Then, push down the button of the "⏻" signal on the top.

The instrument carries out all self-check items and shows the Boot Logo. Press the "Utility" button, then, press **H1** button to get access to the "Function" menu. Turn the **M** knob to select **Adjust** and press **H3** button to select "Default". The default attenuation coefficient set value of the probe in the menu is 10X.

### 2. Set the Switch in the Oscilloscope Probe as 10X and Connect the Oscilloscope with CH1 Channel.

Align the slot in the probe with the plug in the CH1 connector BNC, and then tighten the probe with rotating it to the right side.

Connect the probe tip and the ground clamp to the connector of the probe compensator.

### 3. Press the "Autoset" Button.

The square wave of 1 KHz frequency and 5V peak-peak value will be displayed in several seconds (see *Figure 4-7*).

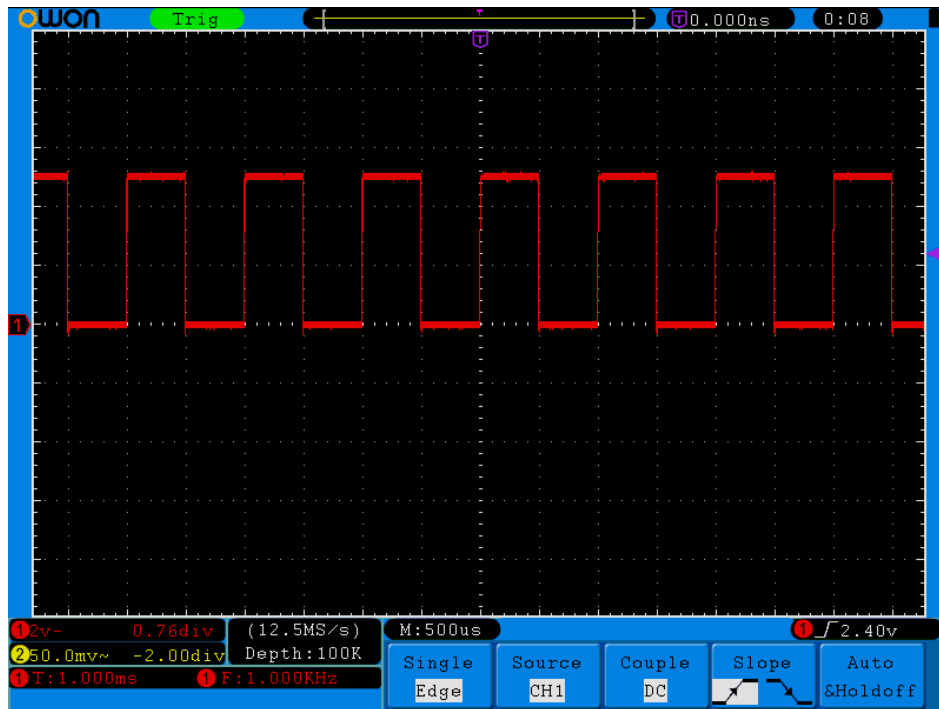

Figure 4-7 Auto set

Check CH2 by repeating Step 2 and Step 3.

## How to Implement the Probe Compensation

When connect the probe with any input channel for the first time, make this adjustment to match the probe with the input channel. The probe which is not compensated or presents a compensation deviation will result in the measuring error or mistake. For adjusting the probe compensation, please carry out the following steps:

1. Set the attenuation coefficient of the probe in the menu as 10X and that of the switch in the probe as 10X (see "*How to Set the Probe Attenuation Coefficient*" on P14), and connect the probe with the CH1 channel. If a probe hook tip is used, ensure that it keeps in close touch with the probe. Connect the probe tip with the signal connector of the probe compensator and connect the reference wire clamp with the ground wire connector of the probe connector, and then press the button "Autoset".
2. Check the displayed waveforms and regulate the probe till a correct compensation is achieved (see *Figure 4-8* and *Figure 4-9*).

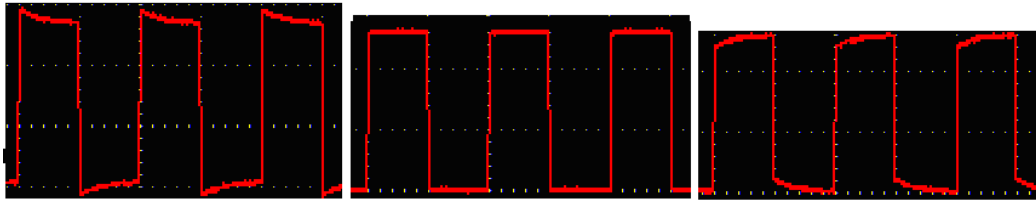

**Overcompensated      Compensated correctly      Under compensated**

Figure 4-8 Displayed Waveforms of the Probe Compensation

3. Repeat the steps mentioned if needed.

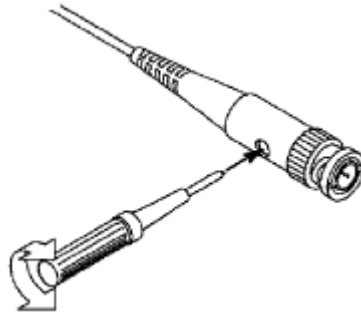

Figure 4-9 Adjust Probe

## How to Set the Probe Attenuation Coefficient

The probe has several attenuation coefficients, which will influence the vertical scale factor of the oscilloscope.

To change or check the probe attenuation coefficient in the menu of oscilloscope:

- (1) Press the function menu button of the used channels (**CH1 MENU** or **CH2 MENU**).
- (2) Press **H3** button to display the Probe menu; press the **F1** button to select **Attenu.**  
In the menu at the left of the screen, turn the **M** knob to select the proper value corresponding to the probe.

This setting will be valid all the time before it is changed again.



### Caution:

The default attenuation coefficient of the probe on the instrument is preset to 10X.

Make sure that the set value of the attenuation switch in the probe is the same as the menu selection of the probe attenuation coefficient in the oscilloscope.

The set values of the probe switch are 1X and 10X (see *Figure 4-10*).

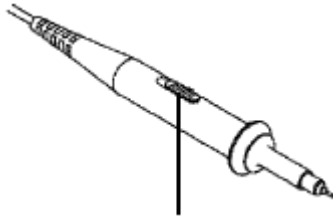

Figure 4-10 Attenuation Switch



**Caution:**

When the attenuation switch is set to 1X, the probe will limit the bandwidth of the oscilloscope in 5MHz. To use the full bandwidth of the oscilloscope, the switch must be set to 10X.

---

## How to Use the Probe Safely

The safety guard ring around the probe body protects your finger against any electric shock, shown as *Figure 4-11*.

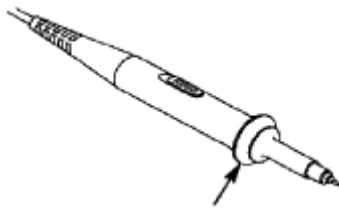

Figure 4-11 Finger Guard



**Warning:**

To avoid electric shock, always keep your finger behind the safety guard ring of the probe during the operation.

To protect you from suffering from the electric shock, do not touch any metal part of the probe tip when it is connected to the power supply.

Before making any measurements, always connect the probe to the instrument and connect the ground terminal to the earth.

---

## How to Implement Self-calibration

The self-calibration application can make the oscilloscope reach the optimum condition rapidly to obtain the most accurate measurement value. You can carry out this application program at any time. This program must be executed whenever the change of ambient temperature is 5°C or over.

Before performing a self-calibration, disconnect all probes or wires from the input connector. Press the "Utility" button, then, press **H1** button to call out the **Function**

menu; turn the **M** knob to choose **Adjust**. Press **H2** button to choose the option "**Self Cal**"; run the program after everything is ready.

## Introduction to the Vertical System

As shown in *Figure 4-12*, there are a few of buttons and knobs in **VERTICAL CONTROLS**. The following practices will gradually direct you to be familiar with the using of the vertical setting.



Figure 4-12 Vertical Control Zone

1. Use the "**VERTICAL POSITION**" knob to show the signal in the center of the waveform window. The "**VERTICAL POSITION**" knob functions the regulating of the vertical display position of the signal. Thus, when the "**VERTICAL POSITION**" knob is rotated, the pointer of the earth datum point of the channel is directed to move up and down following the waveform.

### Measuring Skill

If the channel is under the DC coupling mode, you can rapidly measure the DC component of the signal through the observation of the difference between the waveform and the signal ground.

If the channel is under the AC mode, the DC component would be filtered out. This mode helps you display the AC component of the signal with a higher sensitivity.

### Vertical offset back to 0 shortcut key

Turn the **VERTICAL POSITION** knob to change the vertical display position of channel and press the position knob to set the vertical display position back to 0 as a shortcut key, this is especially helpful when the trace position is far out of the screen and want it to get back to the screen center immediately.

2. Change the Vertical Setting and Observe the Consequent State Information Change.

With the information displayed in the status bar at the bottom of the waveform window, you can determine any changes in the channel vertical scale factor.

- Turn the vertical "**VOLTS/DIV**" knob and change the "Vertical Scale Factor (Voltage Division)", it can be found that the scale factor of the channel corresponding to the status bar has been changed accordingly.
- Press buttons of "**CH1 MENU**", "**CH2 MENU**" and "**Math**", the operation menu, symbols, waveforms and scale factor status information of the corresponding channel will be displayed in the screen.

## Introduction to the Horizontal System

Shown as *Figure 4-13*, there are a button and two knobs in the "**HORIZONTAL CONTROLS**". The following practices will gradually direct you to be familiar with the setting of horizontal time base.



Figure 4-13 Horizontal Control Zone

1. Use the horizontal "**SEC/DIV**" knob to change the horizontal time base setting and observe the consequent status information change. Rotate the horizontal "**SEC/DIV**" knob to change the horizontal time base, and it can be found that the "**Horizontal Time Base**" display in the status bar changes accordingly.
2. Use the "**HORIZONTAL POSITION**" knob to adjust the horizontal position of the signal in the waveform window. The "**HORIZONTAL POSITION**" knob is used to control the triggering displacement of the signal or for other special applications. If it is applied to triggering the displacement, it can be observed that the waveform moves horizontally with the knob when you rotate the "**HORIZONTAL POSITION**" knob.

### Triggering displacement back to 0 shortcut key

Turn the **HORIZONTAL POSITION** knob to change the horizontal position of channel and press the **HORIZONTAL POSITION** knob to set the triggering displacement back to 0 as a shortcut key.

3. With the "**HORIZ MENU**" button, you can do the Window Setting and the Window Expansion.

## Introduction to the Trigger System

As shown in *Figure 4-14*, there are one knob and three buttons make up "**TRIGGER CONTROLS**". The following practices will direct you to be familiar with the setting of the trigger system gradually.



Figure 4-14 Trigger Control Zone

1. Press the "**Trigger Menu**" button and call out the trigger menu. With the operations of the menu selection buttons, the trigger setting can be changed.
2. Use the "**TRIG LEVEL**" knob to change the trigger level setting.  
By rotating the "**TRIG LEVEL**" knob, the trigger indicator in the screen will move up and down. With the movement of the trigger indicator, it can be observed that the trigger level value displayed in the screen changes accordingly.  
**PS:** Turning the **TRIG LEVEL** knob can change trigger level value and it is also the hotkey to set trigger level back to 0.
3. Press the button "**50%**" to set the trigger level as the vertical mid point values of the amplitude of the trigger signal.
4. Press the "**Force**" button to force a trigger signal, which is mainly applied to the "Normal" and "Single" trigger modes.

## 5. Advanced User Guidebook

Up till now, you have already been familiar with the basic operations of the function areas, buttons and knobs in the front panel of the oscilloscope. Based the introduction of the previous Chapter, the user should have an initial knowledge of the determination of the change of the oscilloscope setting through observing the status bar. If you have not been familiar with the above-mentioned operations and methods yet, we advise you to read the section of Chapter 4 "Junior User Guidebook".

This chapter will deal with the following topics mainly:

- **How to Set the Vertical System**
- **How to Set the Horizontal System**
- **How to Set the Trigger System**
- **How to Implement the Sampling Setup**
- **How to Set the Display System**
- **How to Save and Recall Waveform**
- **How to Cut and Recall a waveform**
- **How to Record/Playback Waveforms**
- **How to Implement the Auxiliary System Function Setting**
- **How to Implement the Automatic Measurement**
- **How to Implement the Cursor Measurement**
- **How to Use Autoscale function**
- **How to Use Executive Buttons**

It is recommended that you read this chapter carefully to get acquainted the various measurement functions and other operation methods of the oscilloscope.



## How to Set the Vertical System

The **VERTICAL CONTROLS** includes three menu buttons such as **CH1 MENU**, **CH2 MENU** and **Math**, and four knobs such as **VERTICAL POSITION**, **VOLTS/DIV** for each channel.

### Setting of CH1 and CH2

Each channel has an independent vertical menu and each item is set respectively based on the channel.

### To turn waveforms on or off (channel, math)

Pressing the **CH1 MENU**, **CH2 MENU**, or **Math** buttons have the following effect:

- If the waveform is off, the waveform is turned on and its menu is displayed.
- If the waveform is on and its menu is not displayed, its menu will be displayed.
- If the waveform is on and its menu is displayed, the waveform is turned off and its menu goes away.



CH1 menu



CH2 menu



Couple setting

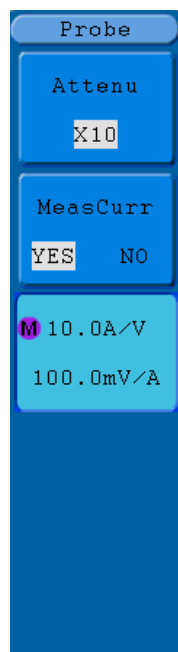

Probe setting



Limit setting

Figure 5-1 Channel Setting Menu (SDS6062(V), SDS7072(V) do not have "Limit" menu)

The description of the Channel Menu is shown as the following list:

Function Menu	Setting		Description
Coupling	DC AC GROUND		Pass both AC and DC components of the input signal. Block the DC component of the input signal. Disconnect the input signal.
Inverted	ON OFF		Display inverted waveform. Display original waveform.
Probe	Attenu	X1 X10 X100 X1000	Match this to the probe attenuation factor to have an accurate reading of vertical scale.
	MeasCurr	YES NO	If you are measuring current by probing the voltage drop across a resistor, choose <b>YES</b> .
	A/V (mA/V) V/A (mV/A)		Turn the <b>M</b> knob to set the Amps/Volts ratio. The range is 100 mA/V - 1 KA/V. Amps/Volts ratio = 1/Resistor value Volts/Amp ratio is automatically calculated.
Limit (SDS6062(V), SDS7072(V) do not have this function)	full band 20M		Get full bandwidth. Limit the channel bandwidth to 20MHz to reduce display noise.

### 1. To set channel coupling

Taking the Channel 1 for example, the measured signal is a square wave signal containing the direct current bias. The operation steps are shown as below:

- (1) Press the **CH1 MENU** button to show the CH1 SETUP menu.
- (2) Press the **H1** button, the Coupling menu will display at the screen.
- (3) Press the **F1** button to select the Coupling item as "**DC**". Both DC and AC components of the signal are passed. The waveforms are shown as *Figure 5-2*.
- (4) Then, press **F2** button to select the Coupling item as "**AC**". The direct current component of the signal is blocked. The waveforms are shown as *Figure 5-3*.

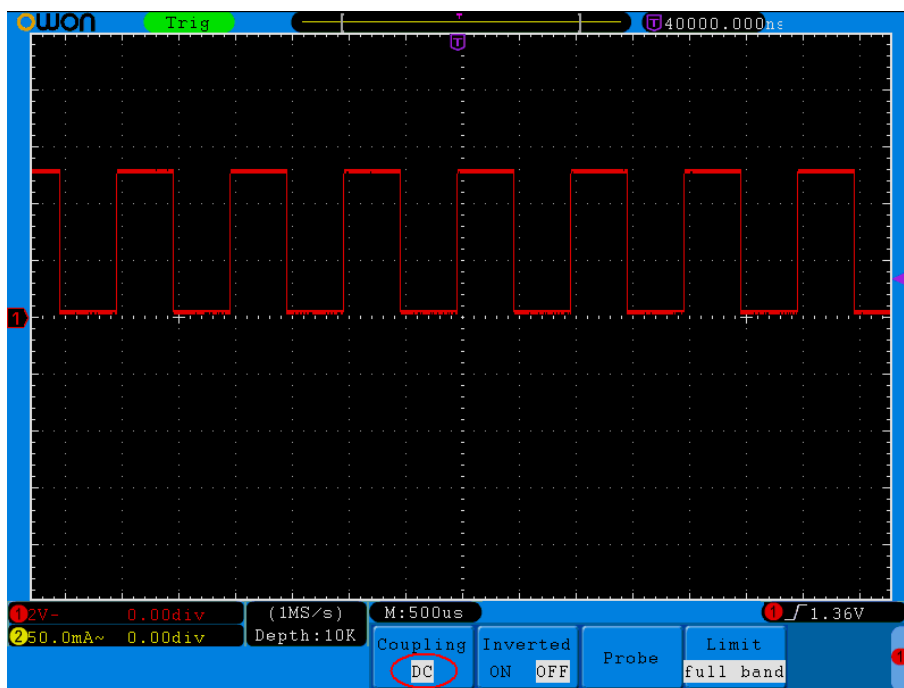

Figure 5-2 DC Coupling Oscillogram

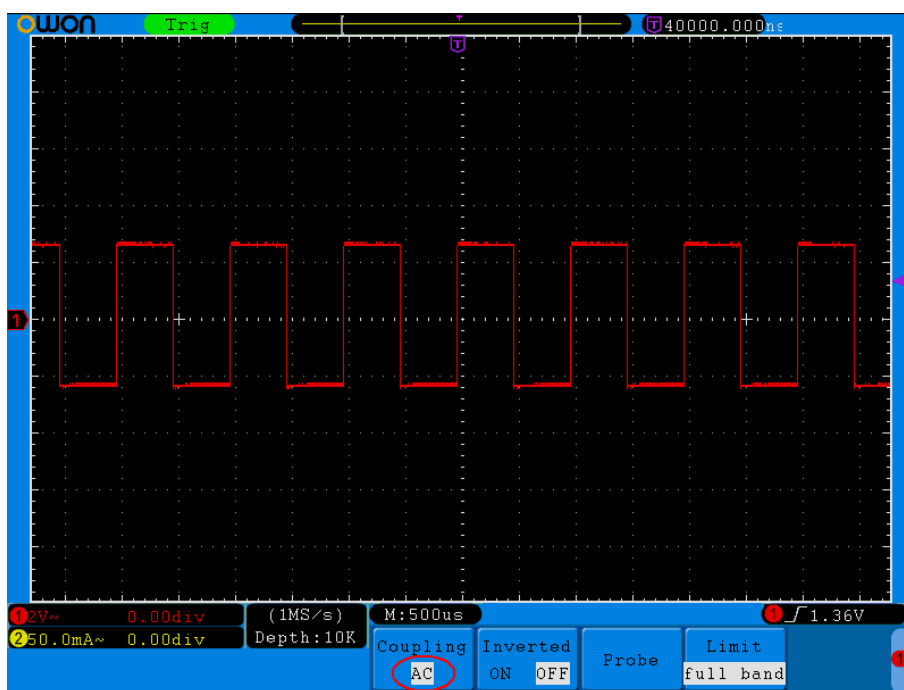

Figure 5-3 AC Coupling Oscillogram

## 2. To adjust the probe attenuation

For correct measurements, the attenuation coefficient settings in the operating menu of the Channel should always match what is on the probe (see "How to Set the Probe Attenuation Coefficient" on P14). If the attenuation coefficient of the probe is 1:1, the menu setting of the input channel should be set to X1.

Take the Channel 1 as an example, the attenuation coefficient of the probe is 10:1, the operation steps are shown as follows:

- (1) Press the **CH1 MENU** button to show the CH1 SETUP menu.
- (2) Press the **H3** menu selection, the Probe menu will display at the right of the screen. Press the **F1** button to select **Attenu**. In the menu at the left of the screen, turn the **M** knob to select **X10** for the probe.

The *Figure 5-4* illustrates the setting and the vertical scale factor when the probe of the attenuation coefficient of 10:1 is used.

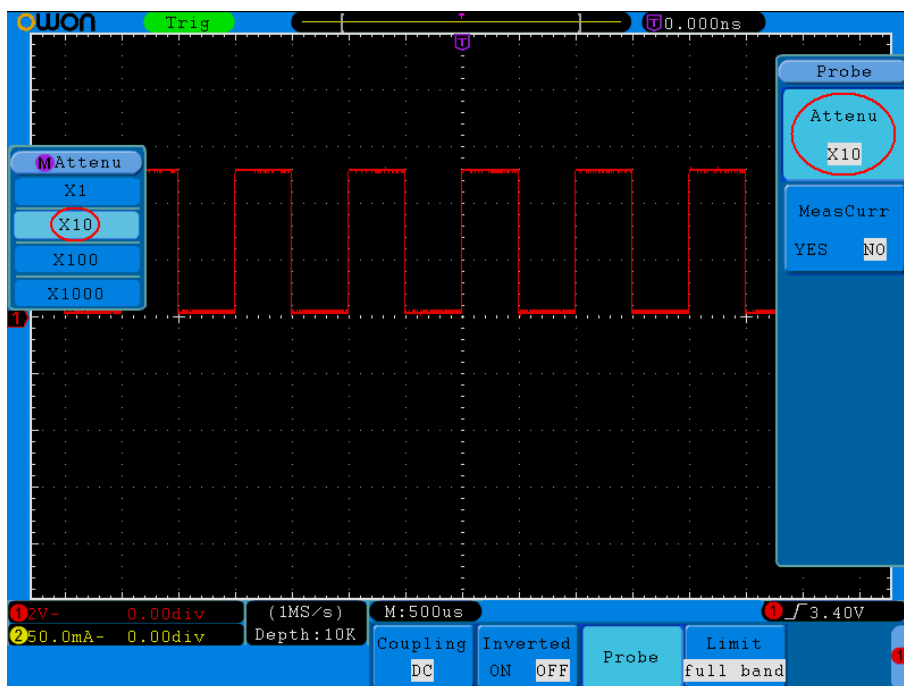

Figure 5-4 Regulation of the Attenuation Ratio of the Probe

A list of the probe attenuation coefficient and the corresponding menu settings:

Attenuation Coefficient of the Probe	Corresponding Menu Setting
1:1	X1
10:1	X10
100:1	X100
1000:1	X1000

### 3. To measure current by probing the voltage drop across a resistor

Take the Channel 1 as an example, if you are measuring current by probing the voltage drop across a  $1\Omega$  resistor, the operation steps are shown as follows:

- (1) Press the **CH1 MENU** button to show CH1 SETUP menu.
- (2) Press the **H3** menu selection, the Probe menu will display at the right of the screen. Press the **F2** button to set **MeasCurr** to **YES**, the A/V ratio menu will appear below. Press the **F3** button; turn the **M** knob to set the Amps/Volts ratio. Amps/Volts ratio =  $1/\text{Resistor value}$ . Here the A/V ratio should be set to 1.

The *Figure 5-5* illustrates the setting and the vertical scale factor when measuring current by probing the voltage drop across a  $1\Omega$  resistor.

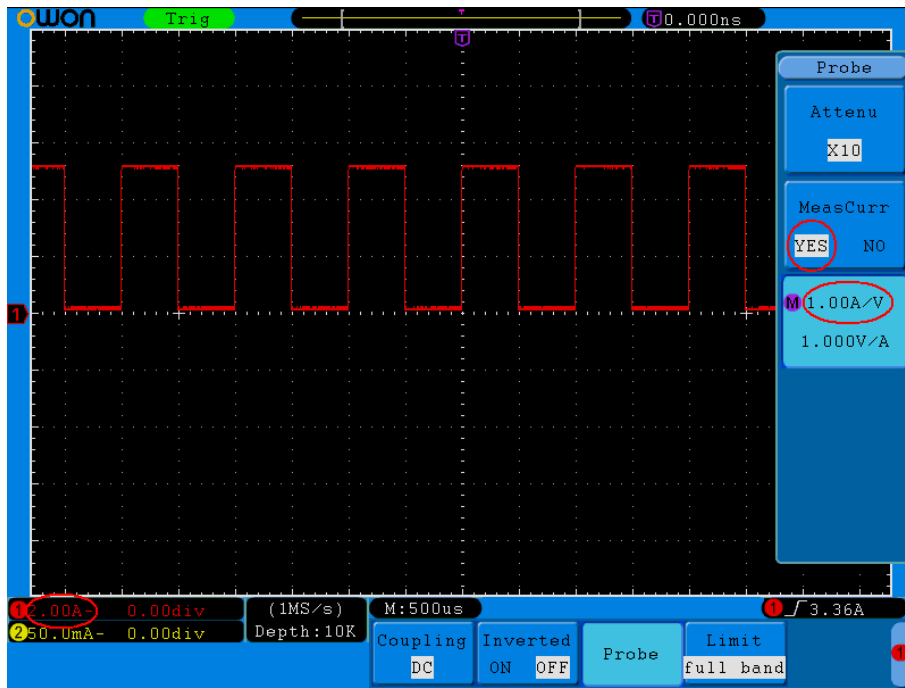

Figure 5-5 Measure Current

#### 4. To invert a waveform

Waveform inverted: the displayed signal is turned 180 degrees against the phase of the earth potential.

Taking the Channel 1 for example, the operation steps are shown as follows:

- (1) Press the **CH1 MENU** button to show the CH1 SETUP menu.
- (2) Press the **H2** menu selection button and select **ON** for **Inverted** item. The waveform is inverted as it is shown in *Figure 5-7*.
- (3) Press the **H2** menu selection button again and select **OFF** for **Inverted** item. The waveform goes back to its original one as it is shown in *Figure 5-6*.

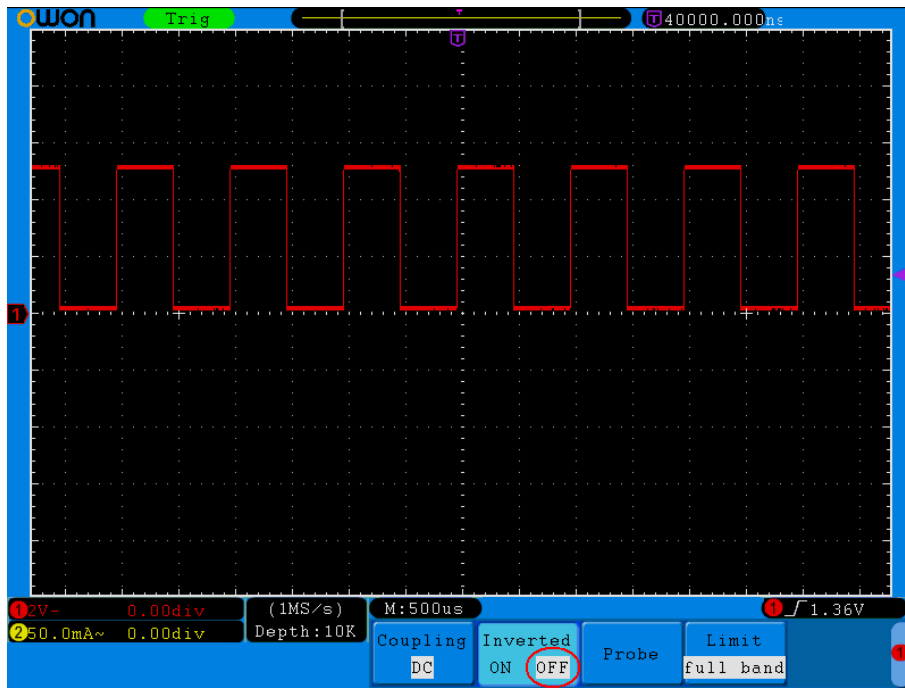

Figure 5-6 Original Waveform

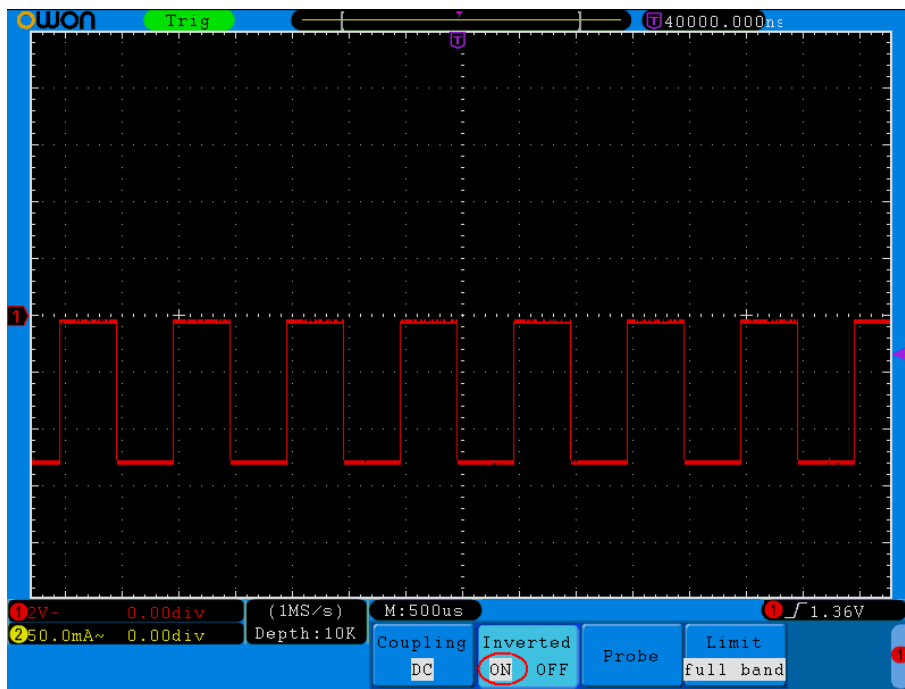

Figure 5-7 Inverted Waveform

5. To set bandwidth limit (SDS6062(V), SDS7072(V) does not have this function)

When high frequency components of a waveform are not important to its analysis, the bandwidth limit control can be used to reject frequencies above 20 MHz.

Taking the Channel 1 for example, the operation steps are shown as below:

- (1) Press the **CH1 MENU** button to show CH1 SETUP menu.
- (2) Press the **H4** button and the **Limit** menu will display.

- (3) Press the **F1** button to select the Band Limit as **full band**. The high frequency of the signal will be allowed to pass.
- (4) Press the **F2** button to select the Band Limit as **20M**. The bandwidth is limited to 20MHz. The frequencies above 20MHz will be rejected.

## Use Mathematical Manipulation Function

The **Mathematical Manipulation** function is used to show the results of the addition, multiplication, division and subtraction operations between Channel 1 and Channel 2, and the FFT operation of Channel 1 or Channel 2.



Figure 5-8 Wave math menu (Filter is only for some models)

The corresponding FCL (Functional Capabilities List) of the **Waveform Calculation:**

Function Menu	Setting	Description
Dual Wfm Math	Factor1	CH1 CH2 Select the signal source of the factor1
	Sign	+ - * / Select the sign of mathematical manipulation
	Factor 2	CH1 CH2 Select the signal source of the factor2
	VERT POS	Turn the <b>M</b> knob to adjust the vertical position of M waveform
	VOLTS/DIV	Turn the <b>M</b> knob to adjust the voltage division of M waveform
FFT	Source	CH1 Select CH1 as FFT source.
		CH2 Select CH2 as FFT source.

	Window	Hamming Rectangle Blackman Hanning	Select window for FFT.
	Format	dB Vrms	Select dB for Format. Select Vrms for Format.
	Zoom	×1 ×2 ×5 ×10	Set multiple ×1. Set multiple ×2. Set multiple ×5. Set multiple ×10.
Filter (Only for some models)	channel	CH1 CH2	Select channel
	type	low-pass high-pass band-pass band-reject	Select Filter type
	window	retangular rectangular triangular Hanning Hamming Blackman	Select window for digital filter
	cut-off fre or upper down		Press <b>F4</b> to switch, turn the <b>M</b> knob to set
	order	19 - 128	Turn the <b>M</b> knob to set

Taking the additive operation between Channel 1 and Channels 2 for example, the operation steps are as follows:

1. Press the **Math** button to bring up the **Wfm Math** menu.
2. Press the **H1** button and call out the **Dual Wfm Math** menu. The menu will display at the left of the screen.
3. Press the **F1** menu selection button and choose **CH1** for Factor1.
4. Press the **F2** menu selection button and choose +.
5. Press the **F3** menu selection button and choose **CH2** for Factor2. The green calculated waveform M is displayed in the screen.



6. Press the **F4** menu selection button and choose **VERT POS**, turn the **M** knob to adjust the vertical position of M waveform.
7. Press the **F5** menu selection button and choose **VOLTS/DIV**, turn the **M** knob to adjust the voltage division of M waveform.

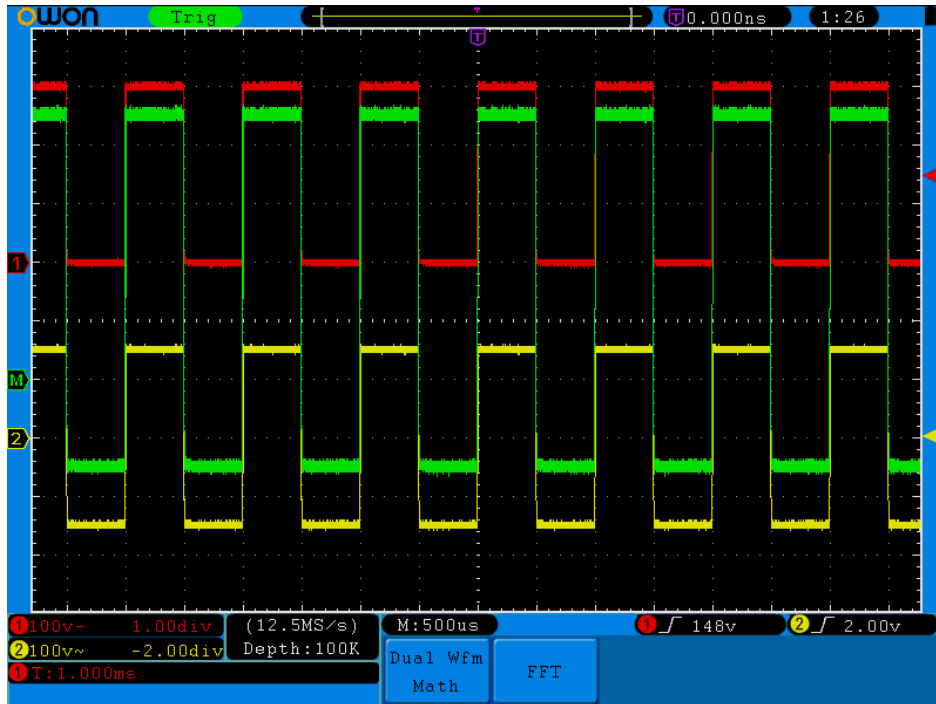

Figure 5-9 Waveform resulted from CH1 +CH2

## Using FFT function

The FFT (fast Fourier transform) math function mathematically converts a time-domain waveform into its frequency components. It is very useful for analyzing the input signal on Oscilloscope. You can match these frequencies with known system frequencies, such as system clocks, oscillators, or power supplies.

FFT function in this oscilloscope transforms 2048 data points of the time-domain signal into its frequency components mathematically and the final frequency contains 1024 points ranging from 0Hz to Nyquist frequency.

Taking the FFT operation for example, the operation steps are as follows:

1. Press the **Math** button and call out the Math menu.
2. Press the **H2** button and call out the **FFT** menu.
3. Press the **F1** button to choose **CH1** as the source.
4. Press **F2** button, the windows item will display at the left of the screen, turn the **M** knob to select **Window**, including Rectangle, Hamming, Hanning and Blackman.
5. Press **F3** button to choose the Format, including dB, Vrms.
6. Press **F4** button, the zoom window will display at the left of the screen, turn the **M** knob to zoom in or out the wave of the multiple including  $\times 1$ ,  $\times 2$ ,  $\times 5$ ,  $\times 10$ .

### To select the FFT window

- There are four FFT windows. Each one has trade-offs between frequency resolution and

magnitude accuracy. What you want to measure and your source signal characteristics help you to determine which window to use. Use the following guidelines to select the best window.





Type	Characteristics	Window
Hamming	<p>Better solution for magnitude than Rectangle, and good for frequency as well. It has slightly better frequency resolution than Hanning.</p> <p>Recommend to use for:</p> <ul style="list-style-type: none"> <li>● Sine, periodic and narrow band random noise.</li> <li>● Transients or bursts where the signal levels before and after the event are significantly different.</li> </ul>	
Rectangle	<p>Best solution for frequency, worst for magnitude.</p> <p>Best type for measuring the frequency spectrum of nonrepetitive signals and measuring frequency components near DC.</p> <p>Recommend to use for:</p> <ul style="list-style-type: none"> <li>● Transients or bursts, the signal level before and after the event are nearly equal.</li> <li>● Equal-amplitude sine waves with frequencies those are very close.</li> <li>● Broadband random noise with a relatively slow varying spectrum.</li> </ul>	
Blackman	<p>Best solution for magnitude, worst for frequency.</p> <p>Recommend to use for:</p> <ul style="list-style-type: none"> <li>● Single frequency waveforms, to find higher order harmonics.</li> </ul>	
Hanning	<p>Good for magnitude, but poorer frequency resolution than Hamming.</p> <p>Recommend to use for:</p> <ul style="list-style-type: none"> <li>● Sine, periodic and narrow band random noise.</li> <li>● Transients or bursts where the signal levels before and after the event are significantly different.</li> </ul>	

Figure 5-10, Figure 5-11, Figure 5-12, Figure 5-13 are examples for measuring sine wave

with a frequency of 1kHz under the selection of four different windows for FFT:

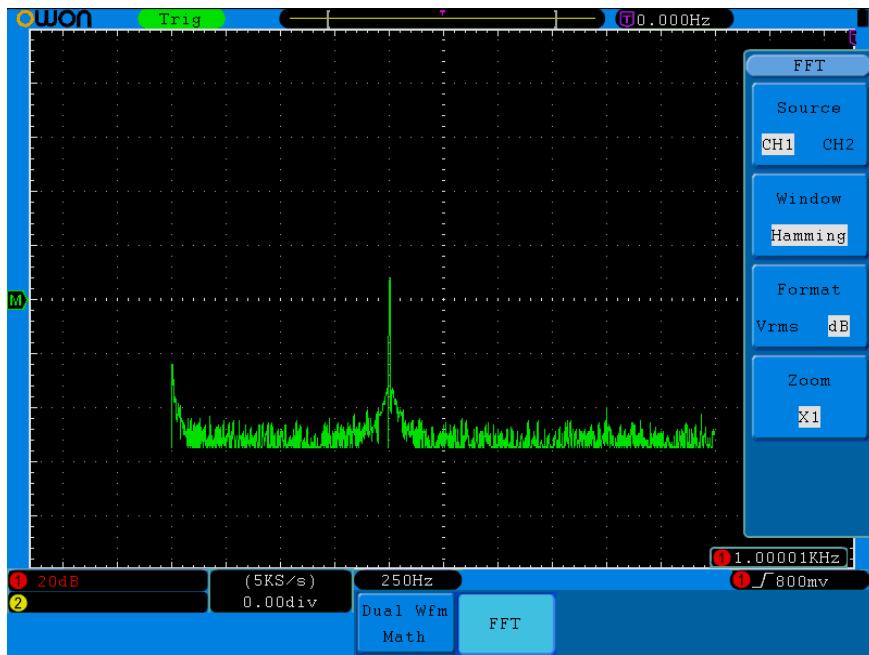

Figure 5-10 Hamming window

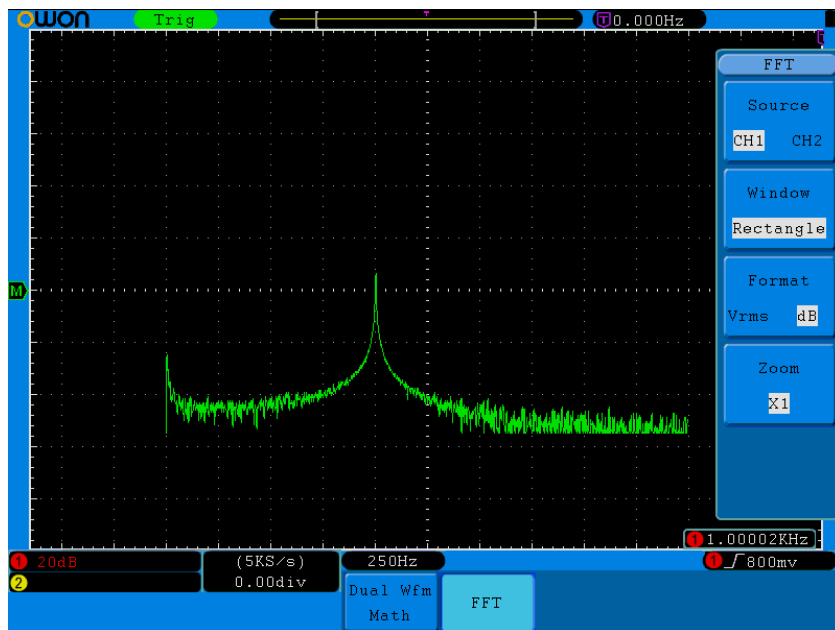

Figure 5-11 Rectangle window

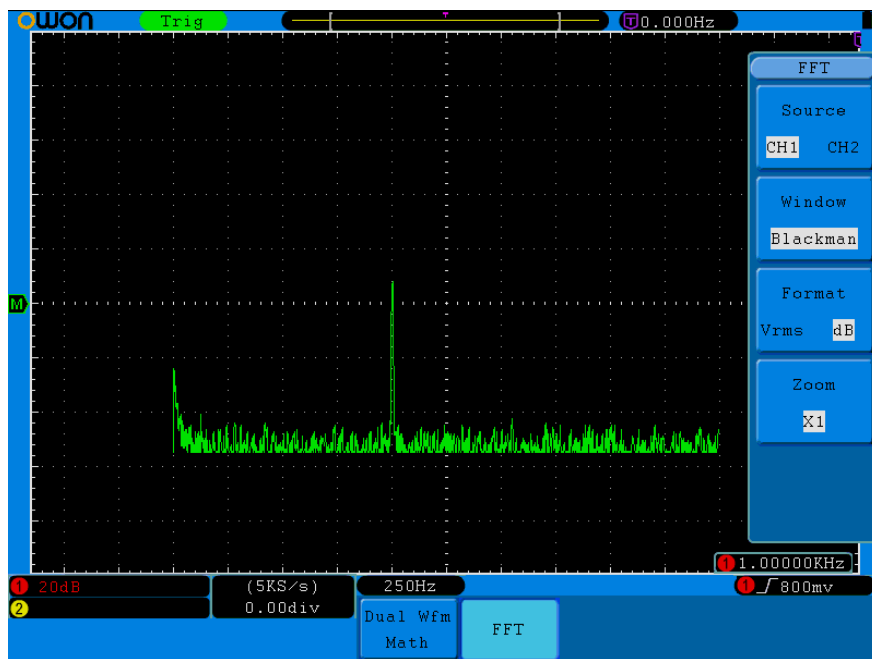

Figure 5-12 Blackman window

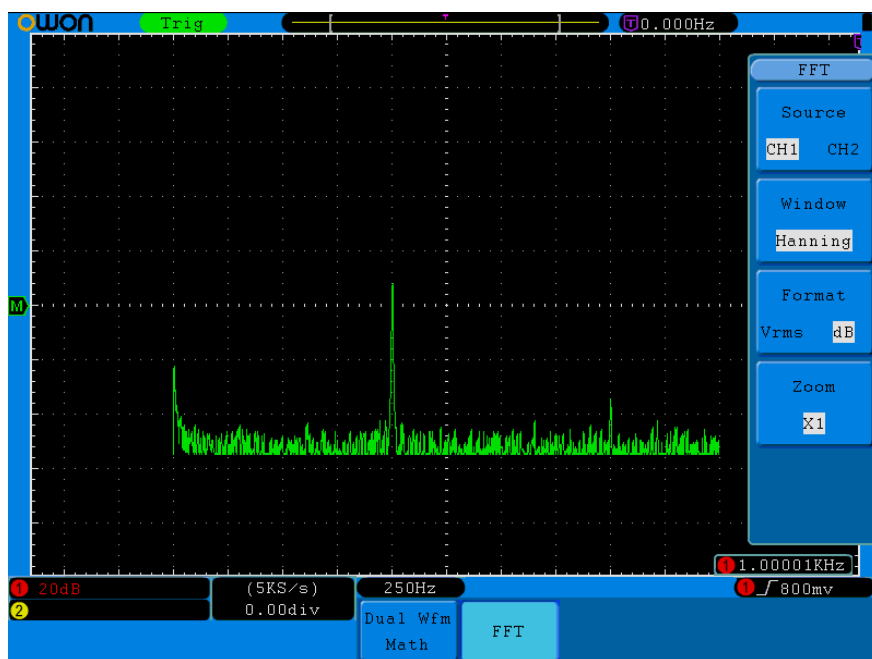

Figure 5-13 Hanning window

### Notes for using FFT

- Use Zoom function to magnify the FFT waveform if necessary.
- Use the default **dB** scale for details of multiple frequencies, even if they have very different amplitudes. Use the **Vrms** scale to compare frequencies.
- DC component or offset can cause incorrect magnitude values of FFT waveform. To minimize the DC component, choose AC Coupling on the source signal.
- To reduce random noise and aliased components in repetitive or single-shot events, set the oscilloscope acquisition mode to average.

### What is Nyquist frequency?

The Nyquist frequency is the highest frequency that any real-time digitizing oscilloscope can acquire without aliasing. This frequency is half of the sample rate. Frequencies above the Nyquist frequency will be under sampled, which causes aliasing. So pay more attention to the relation between the frequency being sampled and measured.

#### Note:

In FFT mode, the following settings are prohibited:

- 1) Window set;
- 2) XY Format in Display SET;
- 3) Measure.

### Digital Filter (Only for some models)

- **Low-pass filter:** Pass signals with a frequency lower than a certain cutoff frequency and attenuates signals with frequencies higher than the cutoff frequency.
- **High-pass filter:** Pass signals with a frequency higher than a certain cutoff frequency and attenuates signals with frequencies lower than the cutoff frequency.
- **Band-pass filter:** Pass frequencies within a certain range and attenuates frequencies outside that range.
- **Band-reject filter:** Pass most frequencies unaltered, but attenuates those in a specific range to very low levels. It is the opposite of a band-pass filter.
- **Cut-off frequency:** A frequency characterizing a boundary between a passband and a stopband. For example, as defined by a 3 dB corner (a frequency for which the output of the circuit is  $-3$  dB of the nominal passband value).
- **Order:** The order of a filter is the degree of the approximating polynomial and in passive filters corresponds to the number of elements required to build it. The higher the order, the more the filter will approach the "ideal" filter; but also the longer the impulse response is and the longer the latency will be. When the high frequency and low frequency of the input signal differ significantly (i.e., 500 Hz – 50 kHz), the order can be set to a small value, such as 29 to 35. When the difference between the high frequency and low frequency is small (i.e., 10 kHz – 50 kHz), the order should be set to a larger value, such as 128.

### Use VERTICAL POSITION and VOLTS/DIV Knobs

1. The **VERTIVAL POSITION** knob is used to adjust the vertical positions of the waveforms, including the captured waveforms and calculated waveforms. The analytic resolution of this control knob changes with the vertical division.
2. The **VOLTS/DIV** knob is used to regulate the vertical resolution of the wave forms, including the captured waveforms and calculated waveforms. The sensitivity of the vertical division steps as 1-2-5. Turning clockwise to increase vertical sensitivity and anti-clockwise to decrease.
3. When the vertical position of the channel waveform is adjusted, the changed

value is displayed at the left bottom corner of the screen (see *Figure 5-14*).

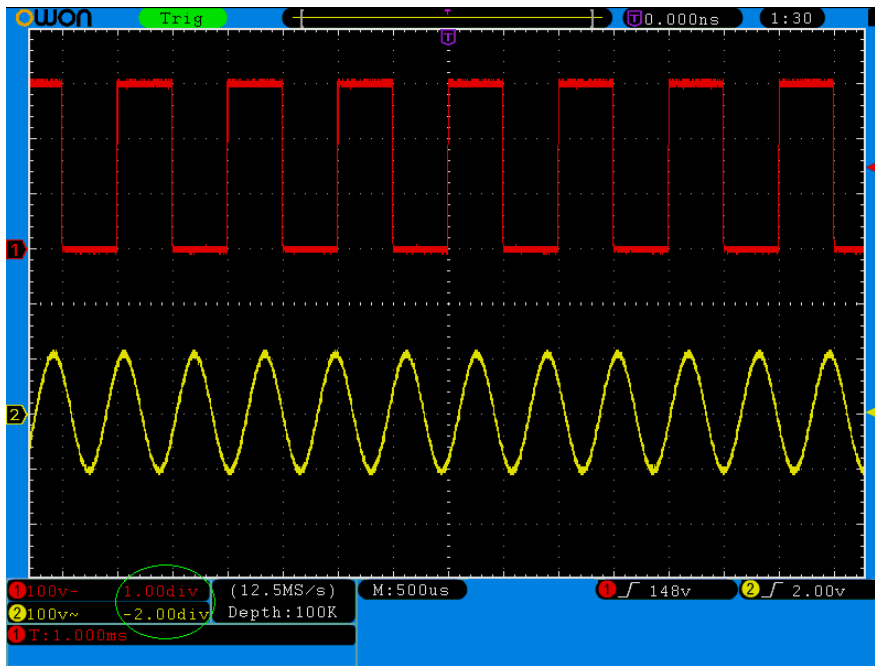

Figure 5-14 Information about Vertical Position

## How to Set the Horizontal System

The **HORIZONTAL CONTROLS** includes the **HORIZ MENU** button and such knobs as **HORIZONTAL POSITION** and **SEC/DIV**.

1. **HORIZONTAL POSITION** knob: this knob is used to adjust the horizontal positions of all channels (include those obtained from the mathematical manipulation), the analytic resolution of which changes with the time base.
2. **SEC/DIV** knob: it is used to set the horizontal scale factor for setting the main time base or the window.
3. **HORIZ MENU** button: with this button pushed down, the screen shows the operating menu (see *Figure 5-15*).

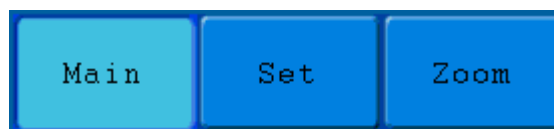

Figure 5-15 Time Base Mode Menu

The description of the **Horizontal Menu** is as follows:

Function Menu	Description
Main (Main Time Base)	The setting of the horizontal main time base is used to display the waveform.
Set (Set Window)	A window area is defined by two cursors. This function is not available at FFT mode.
Zoom (Zoom Window)	The defined window area for display is

	expanded to the full screen.
--	------------------------------

## Main Time Base

Press the **H1** menu selection button and choose **Main**. In this case, the **HORIZONTAL POSITION** and **SEC/DIV** knobs are used to adjust the main window. The display in the screen is shown as *Figure 5-16*.

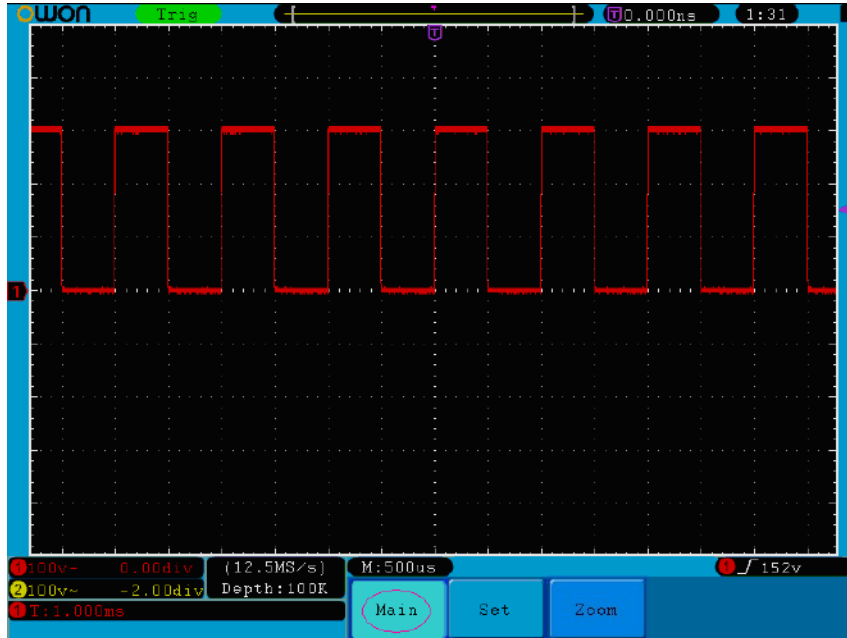

Figure 5-16 Main Time Base

## Set Window

Press the **H2** menu selection button and choose **Set**. The screen will show a window area defined by two cursors. Use the **HORIZONTAL POSITION** and **SEC/DIV** knobs to adjust the horizontal position and size of this window area. In FFT mode, **Set** menu is invalid. See *Figure 5-17*.

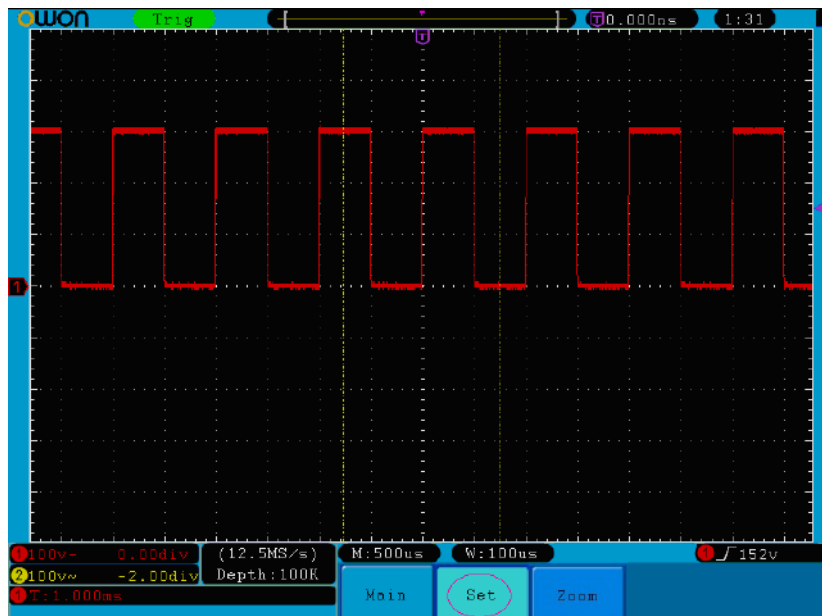

Figure 5-17 Window Setting

## Window Expansion

Press the **H3** menu selection button and choose **Zoom**. As a result, the window area defined by two cursors will be expanded to the full screen size (see *Figure 5-18*).

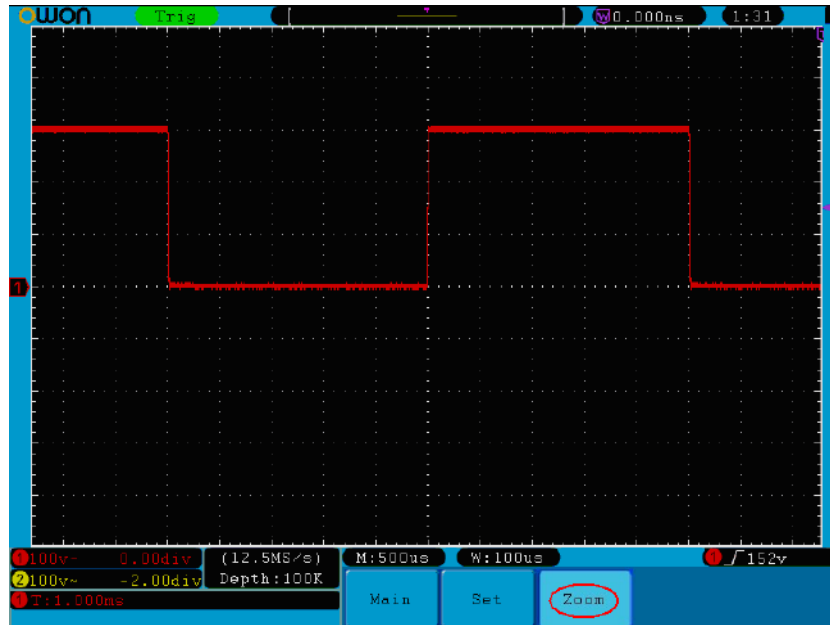

Figure 5-18 Zoom Window



## How to Set the Trigger System

Trigger determines when DSO starts to acquire data and display waveform. Once trigger is set correctly, it can convert the unstable display to meaningful waveform.

When DSO starts to acquire data, it will collect enough data to draw waveform on left of trigger point. DSO continues to acquire data while waiting for trigger condition to occur. Once it detects a trigger it will acquire enough data continuously to draw the waveform on right of trigger point.

Trigger control area consists of 1 knob and 3 menu keys.

**TRIG LEVEL:** The knob that set the trigger level; press the knob and the level will be cleaned to Zero.

**50%:** The instant execute button setting the trigger level to the vertical midpoint between the peaks of the trigger signal.

**Force:** Force to create a trigger signal and the function is mainly used in "Normal" and "Single" mode.

**Trigger Menu:** The button that activates the trigger control menu.

### Trigger Control

The oscilloscope provides two trigger types: single trigger and alternate trigger.

**Single trigger:** Use a trigger level to capture stable waveforms in two channels simultaneously.

**Alternate trigger:** Trigger on non-synchronized signals.

The **Single Trigger** and **Alternate Trigger** menus are described respectively as follows:

#### Single trigger

Single trigger has four modes: edge trigger, video trigger, slope trigger and pulse trigger.

**Edge Trigger:** It occurs when the trigger input passes through a specified voltage level with the specified slope.

**Video Trigger:** Trigger on fields or lines for standard video signal.

**Slope Trigger:** The oscilloscope begins to trigger according to the signal rising or falling speed.

**Pulse Trigger:** Find pulses with certain widths.

The four trigger modes in Single Trigger are described respectively as follows:

#### 1. Edge Trigger



An edge trigger occurs on trigger threshold value of input signal. Select Edge trigger mode to trigger on rising edge or falling edge.

The **Edge Trigger Menu** is shown as *Figure 5-19*.



Figure 5-19 Edge trigger menu

Edge menu list:

Menu	Settings	Instruction
Single Mode	Edge	Set vertical channel trigger type as edge trigger.
Source	CH1	Channel 1 as trigger signal.
	CH2	Channel 2 as trigger signal.
	EXT	External trigger as trigger signal
	EXT/5	1/5 of the external trigger signal as trigger signal.
	AC Line	AC power line as trigger signal.
Coupling	AC	Block the direct current component.
	DC	Allow all component pass.
	HF	Block the high-frequency signal, only low-frequency component pass.
	LF	Block the low-frequency signal, only high-frequency component pass.
Slope		Trigger on rising edge
		Trigger on falling edge
Mode Holdoff	Auto	Acquire waveform even no trigger occurs
	Normal	Acquire waveform when trigger occurs
	Single	When trigger occurs, acquire one waveform then stop
	Holdoff	100 ns - 10 s, turn the <b>M</b> knob to set time interval before another trigger occur.
	Reset	Set Holdoff time as default value (100 ns).

## 2. Video Trigger

Choose video trigger to trigger on fields or lines of NTSC, PAL or SECAM standard video signals.

Trig menu refer to *Figure 5-20*.

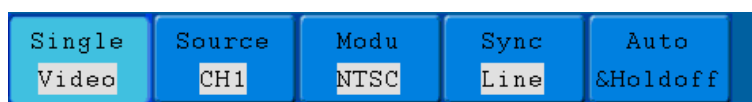

Figure 5-20 Video trigger menu

Video menu list:

MENU	SETTING	INSTRUCTION
Single Mode	Video	Set vertical channel trigger type as video trigger
Source	CH1	Select CH1 as the trigger source
	CH2	Select CH2 as the trigger source
	EXT	The external trigger input
	EXT/5	1/5 of the external trigger source for increasing range of level
Modu	NTSC	Select video modulation
	PAL	
	SECAM	
Sync	Line	Synchronic trigger in video line
	Field	Synchronic trigger in video field
	Odd	Synchronic trigger in video odd filed
	Even	Synchronic trigger in video even field
	Line NO.	Synchronic trigger in designed video line, turn the <b>M</b> knob to set the line number
Mode	Auto	Acquire waveform even no trigger occurred 100 ns - 10 s, adjust the <b>M</b> knob to set time interval before another trigger occur
	Holdoff	
	Reset	

### 3. Slope Trigger

Slope trigger sets the oscilloscope as the positive/negative slope trigger within the specified time.

The **Slope Trigger Menu** is shown as *Figure 5-21*.

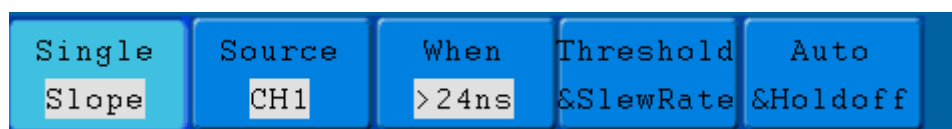
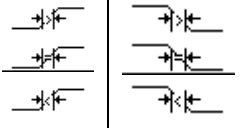

Figure 5-21 Slope trigger menu

Slope trigger menu list:

MENU	SETTING	INSTRUCTION
Single Mode	Slope	Set vertical channel trigger type as slope trigger.
Source	CH1	Select CH1 as the trigger source.
	CH2	Select CH2 as the trigger source.
When		Slope selecting

		Set slope condition; turn the <b>M</b> knob to set slope time.
Threshold & SlewRate	High level Low level Slew rate	Adjust <b>M</b> knob to set the High level upper limit. Adjust <b>M</b> knob to set Low level lower limit. Slew rate = (High level - Low level) / Settings
Mode  Holdoff	Auto Normal Single Holdoff  Reset	Acquire waveform even no trigger occurred Acquire waveform when trigger occurred When trigger occurs, acquire one waveform then stop 100 ns – 10 s, turn the <b>M</b> knob to set time interval before another trigger occur. Set Holdoff time as 100 ns

### 4. Pulse Width Trigger

Pulse trigger occurs according to the width of pulse. The abnormal signals can be detected through setting up the pulse width condition.

The **Pulse Width Trigger Menu** is shown as *Figure 5-22*.

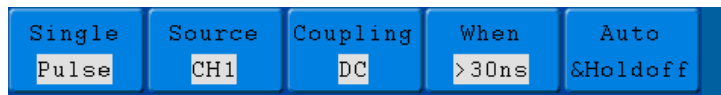

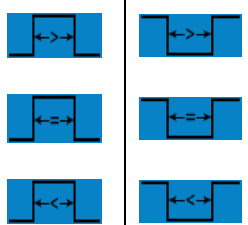

Figure 5-22 Pulse Width Trigger menu

Pulse Width Trigger menu list:

MENU	SETTING	INSTRUCTION
Single Mode	Pulse	Set vertical channel trigger type as pulse trigger.
Source	CH1 CH2	Select CH1 as the trigger source. Select CH2 as the trigger source.
Coupling	AC DC HF  LF	Not allow DC portion to pass. Allow all portion pass. Not allow high frequency of signal pass and only low frequency portion pass. Not allow low frequency of signal pass and only high frequency portion pass
when	Polarity 	Choose the polarity
		Select pulse width condition and adjust the <b>M</b> knob to set time.

Mode	Auto	Acquire waveform even no trigger occurred
	Normal	Acquire waveform when trigger occurred
	Single	When trigger occurs, acquire one waveform then stop
Holdoff	Holdoff	100 ns - 10 s, adjust <b>M</b> knob to set time interval before another trigger occur.
	Reset	Set Holdoff time as 100 ns

### Alternate trigger

Trigger signal comes from two vertical channels when alternate trigger is on. This mode is used to observe two unrelated signals. You can choose different trigger modes for different channels. The options are as follows: edge, video, pulse or slope.

#### 1. Alternate trigger (Trigger mode: Edge)

Alternate trigger (Trigger Type: Edge) Menu is shown as *Figure 5-23*.

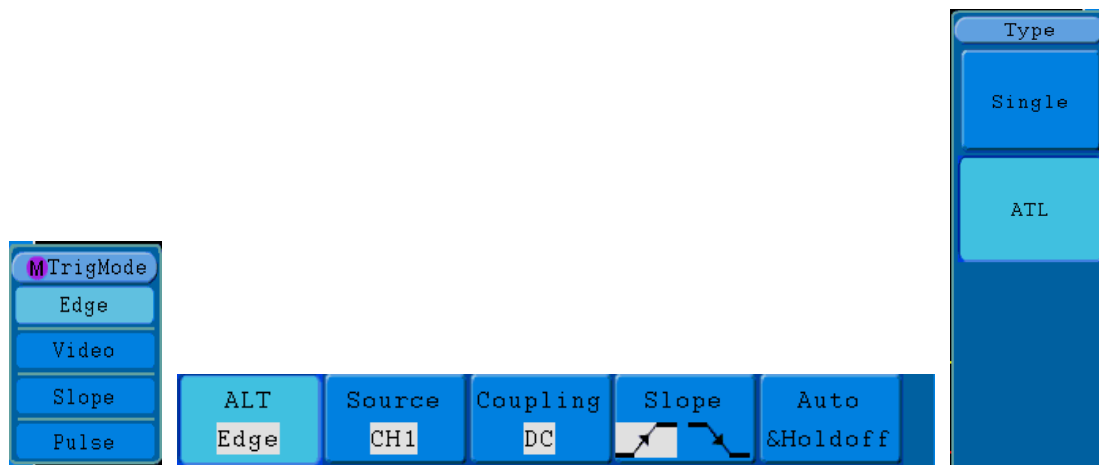



Figure 5-23 Alternate trigger (Trigger Type: Edge) Menu

Alternate trigger (Trigger Type: Edge) Menu list:

MENU	SETTING	INSTRUCTION
Alternate Mode	Edge	Set vertical channel trigger type as edge trigger.
Source	CH1 CH2	Select CH1 as the trigger source. Select CH2 as the trigger source.
Coupling	AC DC HF LF	Not allow DC portion to pass. Allow all portion pass. Not allow high frequency of signal pass and only low frequency portion pass. Not allow low frequency of signal pass and only high frequency portion pass.
Slope	 	Trigger in signal rising edge Trigger in signal falling edge
Mode	Auto	Acquire waveform even no trigger occurred
Holdoff	Holdoff	100 ns - 10 s, adjust <b>M</b> knob to set time interval before another trigger occur.
	Reset	Set Holdoff time as 100 ns

## 2. Alternate trigger (Trigger Mode: video)

Alternate trigger (Trigger Type: video) Menu is shown as *Figure 5-24*.



Figure 5-24 Alternate trigger (Trigger Type: video) Menu

Alternate trigger (Trigger Type: video) Menu list:

MENU	SETTING	INSTRUCTION
Alternate Mode	Video	Set vertical channel trigger type as video trigger.
Source	CH1 CH2	Select CH1 as the trigger source. Select CH2 as the trigger source.
Modu	NTSC PAL SECAM	Select video modulation
Sync	Line Field Odd Field Even Field Line NO.	Synchronic trigger in video line. Synchronic trigger in video field. Synchronic trigger in video odd filed Synchronic trigger in video even field Synchronic trigger in designed video line, turn the <b>M</b> knob to set the line number
Mode	Auto Holdoff	Acquire waveform even no trigger occurred 100 ns - 10 s, adjust the <b>M</b> knob to set time interval before another trigger occur.
Holdoff	Reset	Set Holdoff time as 100 ns

## 3. Alternate trigger (Trigger Mode: Slope)

Alternate trigger (Trigger Type: Slope) Menu is shown as *Figure 5-25*.

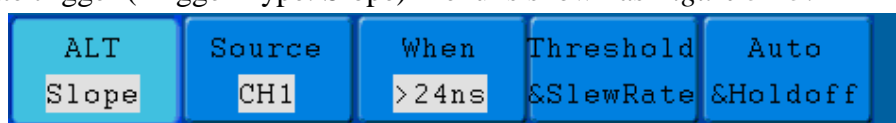

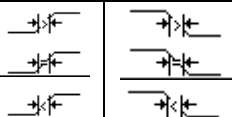

Figure 5-25 Alternate trigger (Trigger Type: Slope) Menu

Alternate trigger (Trigger Type: Slope) menu list:

MENU	SETTING	INSTRUCTION
Alternate Mode	Slope	Set vertical channel trigger type as slope trigger.
Source	CH1 CH2	Select CH1 as the trigger source. Select CH2 as the trigger source.
When		Select slope condition
		Set slope condition; turn the <b>M</b> knob to set time.

Threshold	High level	Turn the <b>M</b> knob to set the High level
	Low level	Turn the <b>M</b> knob to set Low level
	Slew rate	Slew rate=( High level- Low level)/ Settings
Mode	Auto	Acquire waveform even no trigger occurred
Holdoff	Holdoff	100 ns - 10 s, adjust the <b>M</b> knob to set time interval before another trigger occur.
	Reset	Set Holdoff time as 100 ns

#### 4. Alternate trigger (Trigger Mode: Pulse)

Alternate trigger (Trigger Type: Pulse) Menu is shown as *Figure 5-26*.

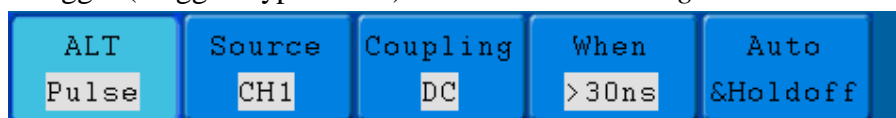

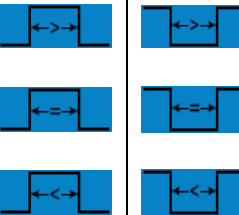

Figure 5-26 Alternate trigger (Trigger Type: Pulse) Menu

Alternate trigger (Trigger Type: Pulse) menu list:

MENU	SETTING	INSTRUCTION
Alternate Mode	Pulse	Set vertical channel trigger type as pulse trigger.
Source	CH1 CH2	Select CH1 as the trigger source. Select CH2 as the trigger source.
Coupling	AC	Not allow DC portion to pass.
	DC	Allow all portion pass.
	HF	Not allow high frequency of signal pass and only low frequency portion pass.
	LF	Not allow low frequency of signal pass and only high frequency portion pass.
when	Polarity 	Choose the polarity
		Select pulse width condition and turn the <b>M</b> knob to set time.
Mode	Auto	Acquire waveform even no trigger occurred
Holdoff	Holdoff	100 ns - 10 s, adjust <b>M</b> knob to set time interval before another trigger occur.
	Reset	Set Holdoff time as 100 ns

#### Term interpretation

**1. Source:** Trigger can occur from several sources: Input channels (CH1, CH2), AC Line, Ext, Ext/5.

- **Input:** It is the most commonly used trigger source. The channel will work when

selected as a trigger source whatever displayed or not.

- **Ext Trig:** The instrument can be triggered from a third source while acquiring data from CH1 and CH2. For example, to trigger from an external clock or with a signal from another part of the test circuit. The EXT, EXT/5 trigger sources use the external trigger signal connected to the EXT TRIG connector. Ext uses the signal directly; it has a trigger level range of  $-0.6\text{V}$  to  $+0.6\text{V}$ . The EXT/5 trigger source attenuates the signal by 5X, which extends the trigger level range to  $-3\text{V}$  to  $+3\text{V}$ . This allows the oscilloscope to trigger on a larger signal.
- **AC Line:** AC power can be used to display signals related to the power line frequency, such as lighting equipment and power supply devices. The oscilloscope gets triggered on its power cord, so you do not have to input an AC trigger signal. When AC Line is selected as trigger source, the oscilloscope automatically set coupling to DC, set trigger level to 0V.

### 2. Trigger Mode:

The trigger mode determines how the oscilloscope behaves in the absence of a trigger event. The oscilloscope provides three trigger modes: Auto, Normal, and Single.

- **Auto:** This sweep mode allows the oscilloscope to acquire waveforms even when it does not detect a trigger condition. If no trigger condition occurs while the oscilloscope is waiting for a specific period (as determined by the time-base setting), it will force itself to trigger.
- **Normal:** The Normal mode allows the oscilloscope to acquire a waveform only when it is triggered. If no trigger occurs, the oscilloscope keeps waiting, and the previous waveform, if any, will remain on the display. **Single:** In Single mode, after pressing the **Run/Stop** key, the oscilloscope waits for trigger. While the trigger occurs, the oscilloscope acquires one waveform then stop.
- **Single:** In Single mode, after pressing the **Run/Stop** key, the oscilloscope waits for trigger. While the trigger occurs, the oscilloscope acquires one waveform then stop.

### 3. Coupling:

Trigger coupling determines what part of the signal passes to the trigger circuit.

Coupling types include AC, DC, LF Reject and HF Reject.

- **AC:** AC coupling blocks DC components.
- **DC:** DC coupling passes both AC and DC components.
- **LF Reject:** LF Reject coupling blocks DC component, and attenuates all signal with a frequency lower than 8 kHz.
- **HF Reject:** HF Reject coupling attenuates all signals with a frequency higher than 150 kHz.

**4. Holdoff:** Trigger holdoff can be used to stabilize a waveform. The holdoff time is the oscilloscope's waiting period before starting a new trigger. The oscilloscope will not trigger until the holdoff time has expired. It provides a chance for user to check the signal in a short period and helps to check some complex signals, such as AM waveform etc.



## How to Operate the Function Menu

The function menu control zone includes 8 function menu buttons: **Measure, Acquire, Utility, Cursor, Autoscale, Save, Display, Help** and 4 immediate-execution buttons: **Autoset, Run/Stop, Single, Copy**.

### How to Implement Sampling Setup

Press the **Acquire** button and the menu is displayed in the screen, shown as *Figure 5-27*.

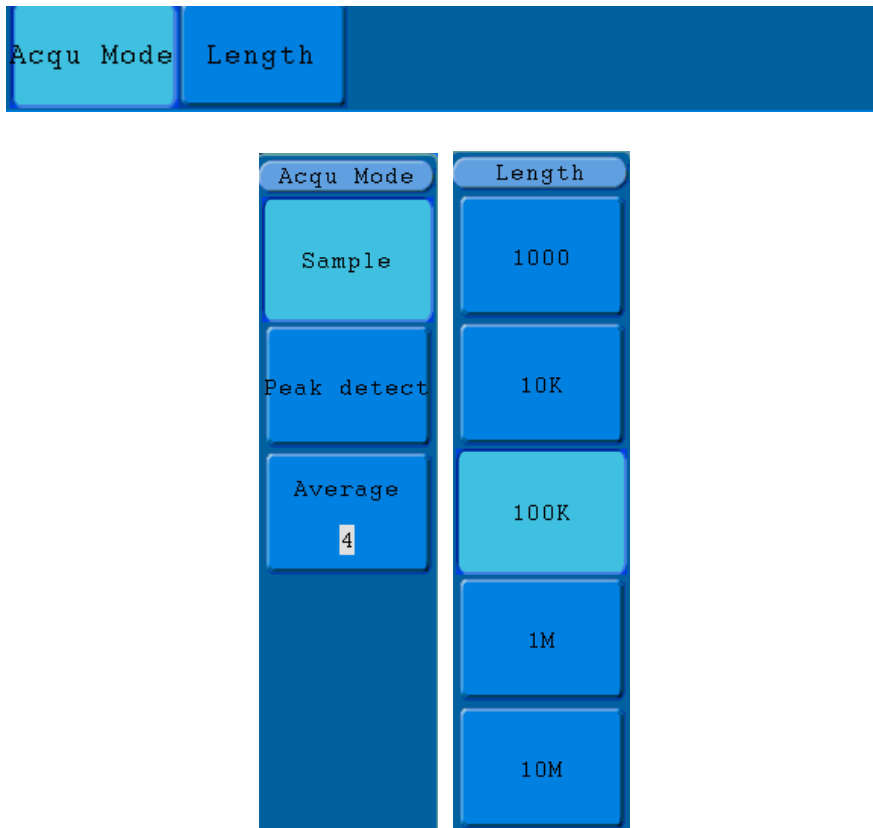

Figure 5-27 ACQU MODE Menu

The description of the **Acqu Mode Menu** is shown as follows:

Function Menu	Setting	Description
Sample	Sample	Normal sampling mode.
	Peak detect	Use to capture maximal and minimal samples. Finding highest and lowest points over adjacent intervals. It is used for the detection of the jamming burr and the possibility of reducing the confusion.
	Average	4, 16, 64, 128

The description of the **Record Length Menu** is shown as follows:

Function Menu	Setting	Description
Length	1000	Choose the record length
	10K	
	100K	
	1M	
	10M	

Change the **ACQU Mode** settings and observe the consequent variation of the wave form displayed.

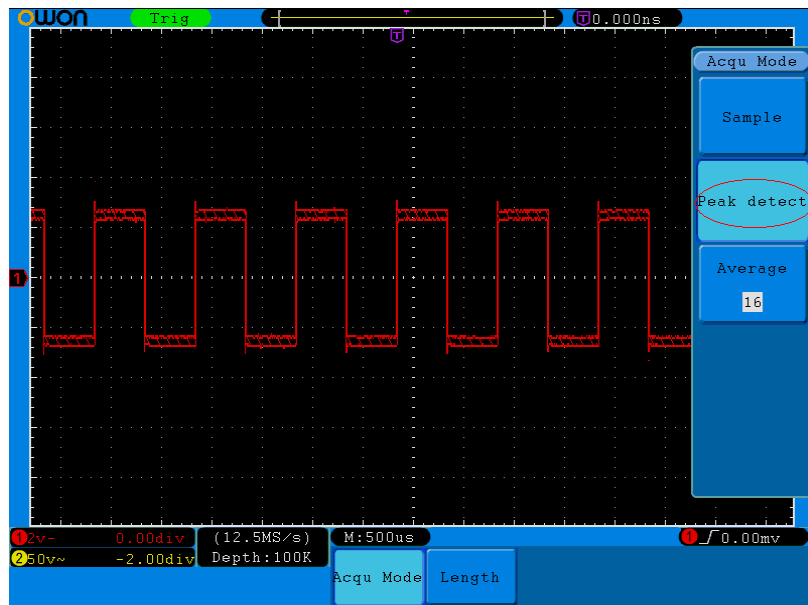

Figure 5-28 Peak Detect mode, under which the burrs on the falling edge of the square wave, can be detected and the noise is heavy.

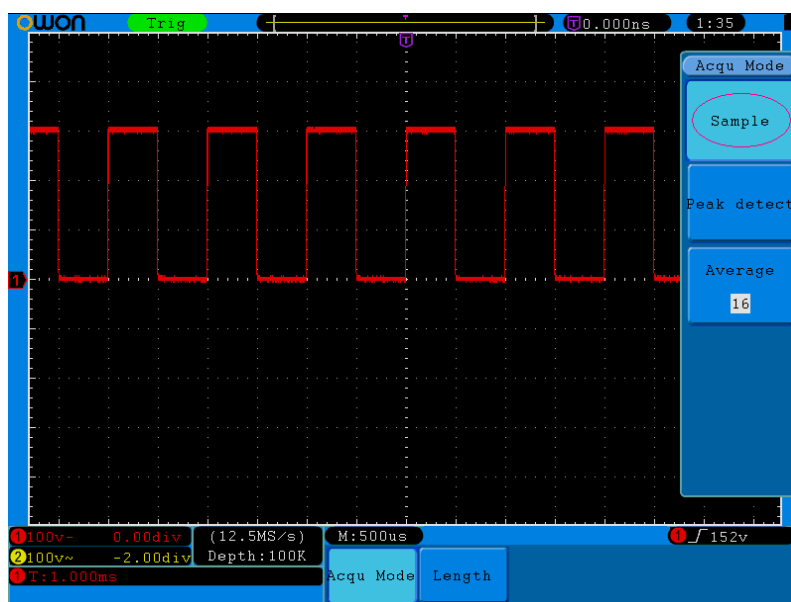

Figure 5-29 Normal **ACQU Mode** display, in which no burr can be detected.

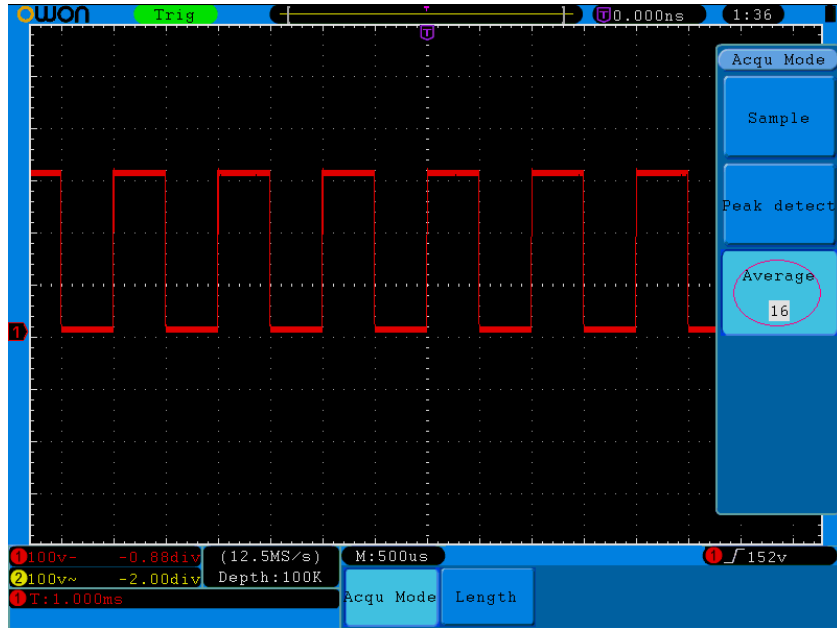

Figure 5-30 The displayed waveform after the noise is removed under the Average Mode, in which the average number of 16 is set.

### How to Set the Display System

Press the **Display** button and the menu displayed in the screen is shown as *Figure 5-31*.

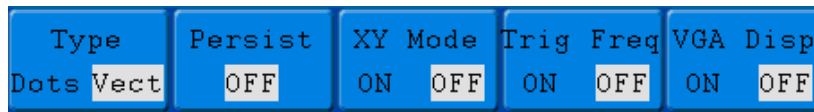

Figure 5-31 Display Set Menu

The description of the **Display Set Menu** is shown as follows:

Function Menu	Setting	Description
Type	Dots Vect	Only the sampling points are displayed. The space between the adjacent sampling points in the display is filled with the vector form.
Persist	Time OFF 1 second 2 seconds 5 seconds Infinity	Turn the <b>M</b> knob to set the persistence time
	Clear	Clear the persistence
XY Mode	ON OFF	Turn on the XY display function; Turn off the XY display function.
Trig Freq	ON OFF	Turn on the Trig Freq; Turn off the Trig Freq.
VGA Disp (only for the model with "V")	ON OFF	Connect the VGA port to a monitor. If set it as ON, the waveform could be displayed on the computer monitor.

**Display Type:** With the **F1** menu selection button pushed down, you can shift between **Vect** and **Dots** types. The differences between the two display types can be observed through the comparison between *Figure 5-32* and *Figure 5-33*.

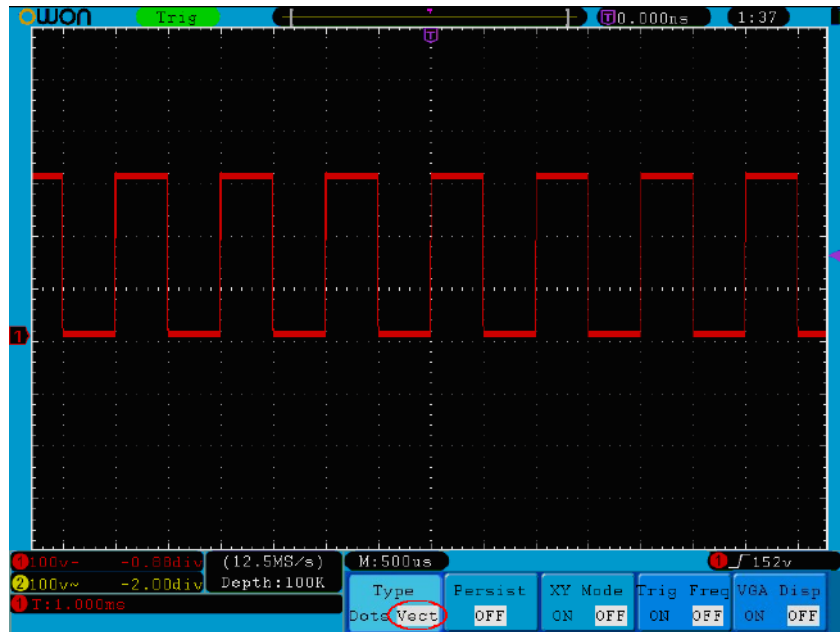

Figure 5-32 Display in the Vector Form

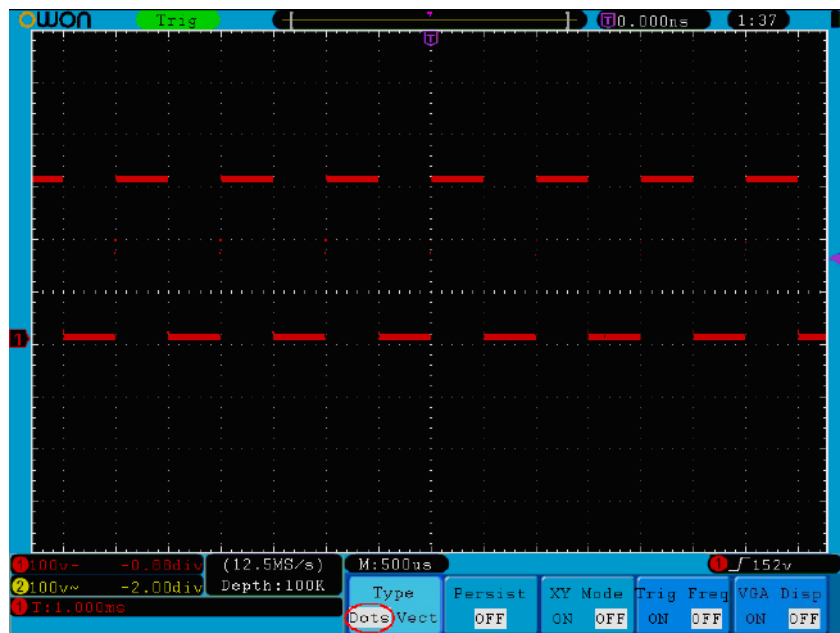

Figure 5-33 Display in Dots form

### Persist

When the **Persist** function is used, the persistence display effect of the picture tube oscilloscope can be simulated. The reserved original data is displayed in fade color and the new data is in bright color. Press the **H2** button, the **Persist** menu will display at the right of screen. Press the **F1** button, different persistence time can be chosen:

**OFF, 1second, 2second, 5second** and **Infinity**. When the "Infinity" option is set for **Persist** time, the measuring points will be stored till the controlling value is changed (see *Figure 5-34*). By pressing the **F2** button, the persistence will be cleared.

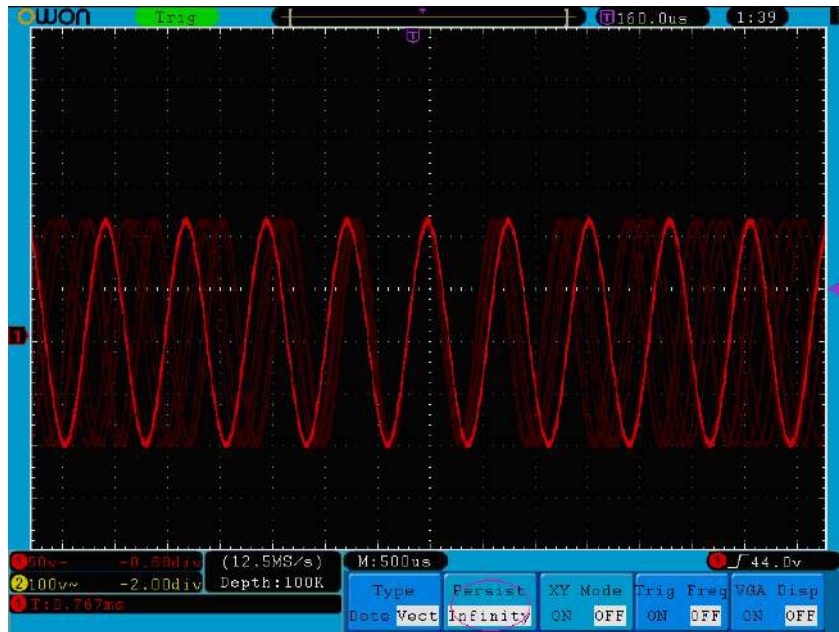

Figure 5-34 Infinite Persistence Display

## XY Format

This format is only applicable to Channel 1 and Channel 2. After the XY display format is selected, Channel 1 is displayed in the horizontal axis and Channel 2 in the vertical axis; the oscilloscope is set in the un-triggered sample mode: the data are displayed as bright spots.

### The operations of all control knobs are as follows:

- The Vertical **VOLTS/DIV** and the **VERTICAL POSITION** knobs of Channel 1 are used to set the horizontal scale and position.
- The Vertical **VOLTS/DIV** and the **VERTICAL POSITION** knobs of Channel 2 are used to set the vertical scale and position continuously.

### The following functions can not work in the XY Format:

- Reference or digital wave form
- Cursor
- Time base control
- Trigger control
- FFT

Operation steps:

1. Press the **Display** button and call out the **Display Set** Menu.
2. Press the **H3** menu selection button to set XY Mode **ON**. The display format is changed to be XY mode (see *Figure 5-35*).

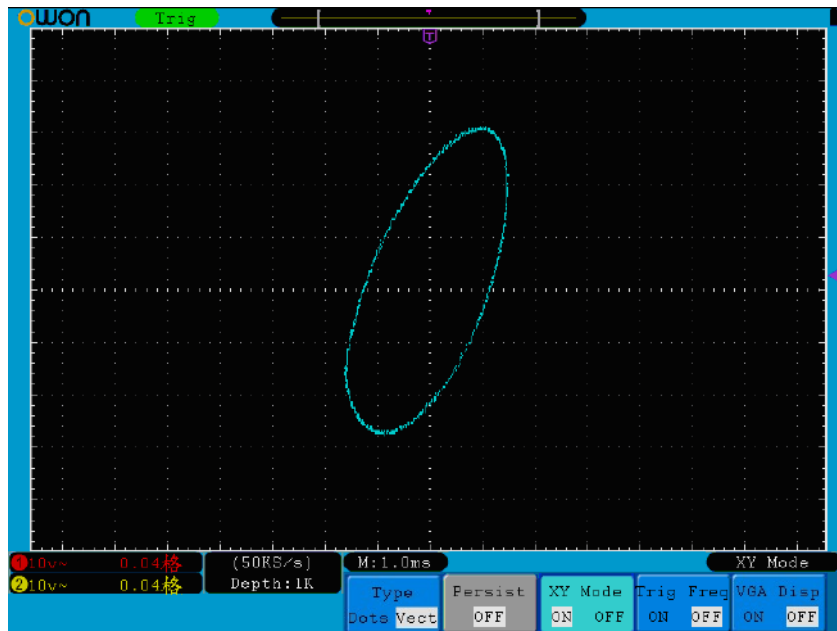

Figure 5-35 XY Display Mode

## Trig Freq

It is a 6-digit trig freq. The trig freq can measure frequencies from 2Hz to the full bandwidth. Only if the measured channel has triggering signal and in **Edge** mode, it can measure frequency correctly. In the **Single** trigger mode, it is a one channel trig freq and it can only measure the frequency of the triggering channel. In the **ALT** trigger mode, it is a two channel trig freq and it can measure the frequency of two channels. The trig freq is displayed at the right bottom of the screen.

To turn the trig freq on or off:

1. Press the **Display** button.
2. In the **Display** menu, press the **H4** button to toggle between the trig freq display **ON** or **OFF**.

## VGA Output (only for the model with "V")

The VGA port could be connected to a computer monitor. The image of the oscilloscope can be clearly displayed on the monitor.

To set the VGA Output:

1. Press the **Display** button.
2. In the **Display** menu, press the **H5** button to toggle between **ON** or **OFF**.

## How to Save and Recall a Waveform

Press the **Save** button, you can save the waveforms, settings or screen images. The menu displayed in the screen is shown as *Figure 5-36*.

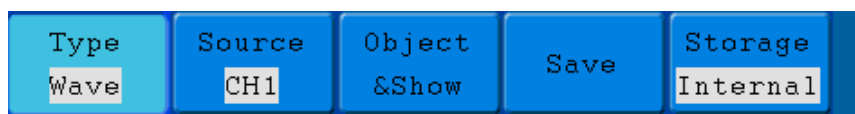

Figure 5-36 Waveform Save Menu

The description of the **Save Function Menu** is shown as the following table:

Function Menu	Setting	Description	
Type	Wave Setting Image Record CutWave	Choose the saving type. About the <b>Record</b> type, see " <i>How to Record/Playback Waveforms</i> " on P60. About the <b>CutWave</b> type, see " <i>How to Cut and Recall a waveform</i> " on P57.	
When the type is <b>Wave</b> , the menu shows as following:			
Source	CH1 CH2 Math	Choose the waveform to be saved.	
Object & Show	Object	1 - 15	Choose the address which the waveform is saved to or recall from.
	Show	ON OFF	Recall or close the waveform stored in the current object address. When the show is ON, if the current object address has been used, the stored waveform will be shown, the address number and relevant information will be displayed at the top left of the screen; if the address is empty, it will prompt "None is saved".
Save		Save the waveform of the source to the selected address. Whatever the <b>Type</b> of save menu is set, you can save the waveform by just pressing the <b>Copy</b> panel button in any user interface. Storage format is BIN.	
Storage	Internal External	Save to internal storage or USB storage. When External is selected, save the waveform according to the current record length (see " <i>Record Length Menu</i> " on P45); the file name is editable. The waveform file could be open by OWON waveform analysis software (on the supplied CD).	
When the type is <b>Setting</b> , the menu shows as following:			

Setting	Setting1 ..... Setting8	The setting address
Save		Save the current oscilloscope setting to the internal storage
Load		Recall the setting from the selected address
When the type is <b>Image</b> , the menu shows as following:		
Save		Save the current display screen. The file can be only stored in a USB storage, so a USB storage must be connected first. The file name is editable. The file is stored in BMP format.

### Save and Recall the Waveform

The oscilloscope can store 15 waveforms, which can be displayed with the current waveform at the same time. The stored waveform called out can not be adjusted.

In order to save the waveform of the CH1 into the address 1, the operation steps should be followed:

1. **Saving:** Press the **H1** button, the **Type** menu will display at the left of screen, turn the **M** knob to choose **Wave** for Type.
2. Press the **H2** button and press **F1** button to select **CH1** for Source.
3. Press the **H3** button and press the **F1**, turn the **M** knob to select **1** as object address.
4. Press the **H5** button and press **F1** button to select **Internal**.
5. Press the **H4** button to save the waveform.
6. **Recalling:** Press the **H3** button, and press the **F1**, turn the **M** knob to select **1** as object address. Press **F2** button to set **Show** as **ON**. The waveform stored in the address will be shown, the address number and relevant information will be displayed at the top left of the screen.



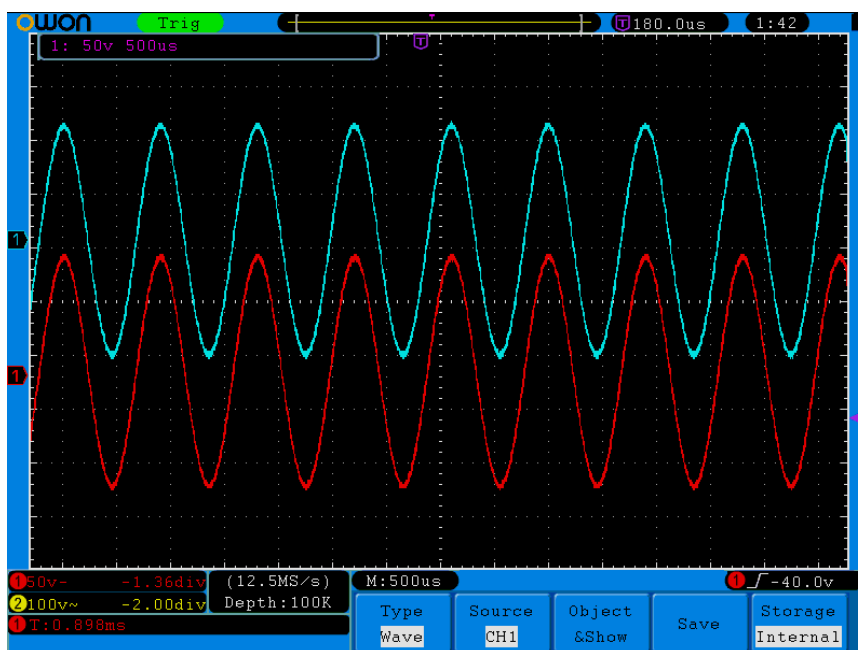



Figure 5-37 Wave Saving

**Tip:**

Whatever the **Type** of save menu is set, you can save the waveform by just pressing the **Copy** panel button in any user interface. If the **Storage** of the save menu is set as "**External**", you should install the USB disk. Please refer to the contents below to install the USB disk and name the file to be saved.

**Save the current screen image:**

The screen image can only be stored in USB disk, so you should connect a USB disk with the instrument.

1. **Install the USB disk:** Insert the USB disk into the "1. **USB Host port**" of "*Figure 4-3 Right side panel*". If an icon  appears on the top right of the screen, the USB disk is installed successfully. If the USB disk cannot be recognized, format the USB disk according to the methods in "*USB disk Requirements*" on P53.
2. After the USB disk is installed, press the **Save** panel button, the save menu is displayed at the bottom of the screen.
3. Press the **H1** button, the **Type** menu will display at the left of screen, turn the **M** knob to choose **Image** for Type.
4. Press the **H4** button, the input keyboard used to edit the file name will pop up. The default name is current system date. Turn the **M** knob to choose the keys; press the **M** knob to input the chosen key. The length of file name is up to 25 characters. Choose and press the **Enter** key of the keyboard to end the input and store the file with the current name.

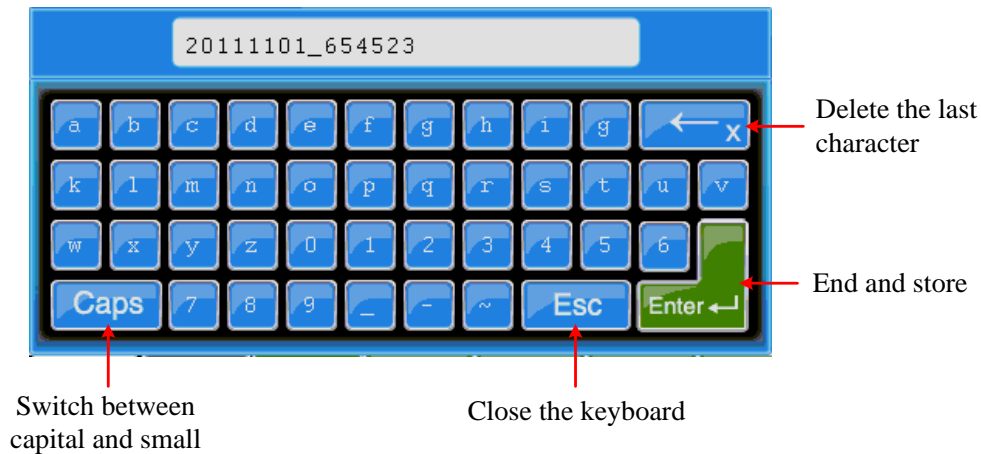

Figure 5-38 Edit the File Name

### USB disk Requirements

The supported format of the USB disk: FAT32 file system, the allocation unit size cannot exceed 4K, mass storage USB disk is also supported. If the USB disk doesn't work properly, format it into the supported format and try again. Follow any of the following two methods to format the USB disk: using system-provided function and using the formatting tools. (The USB disk of 8 G or 8 G above can only be formatted using the second method – using the formatting tools.)

### Use system-provided function to format the USB disk

1. Connect the USB disk to the computer.
2. Right click **Computer**-→ **Manage** to enter Computer Management interface.
3. Click Disk Management menu, and information about the USB disk will display on the right side with red mark 1 and 2.

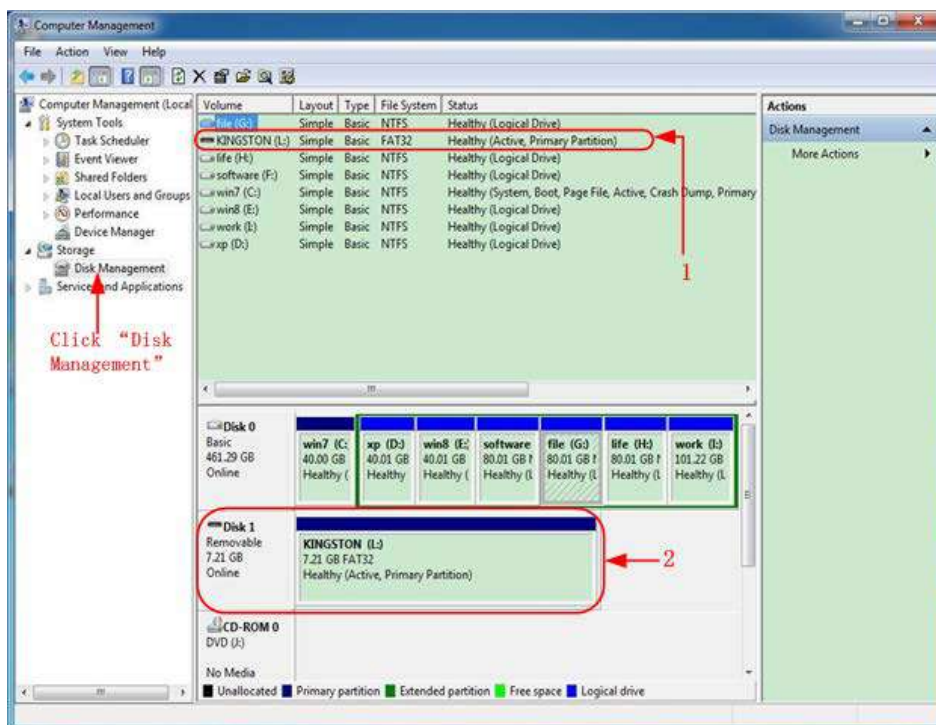

Figure 5-39: Disk Management of computer

- Right click 1 or 2 red mark area, choose **Format**. And system will pop up a warning message, click **Yes**.



Figure 5-40: Format the USB disk warning

- Set File System as FAT32, Allocation unit size 4096. Check "**Perform a quick format**" to execute a quick format. Click **OK**, and then click **Yes** on the warning message.

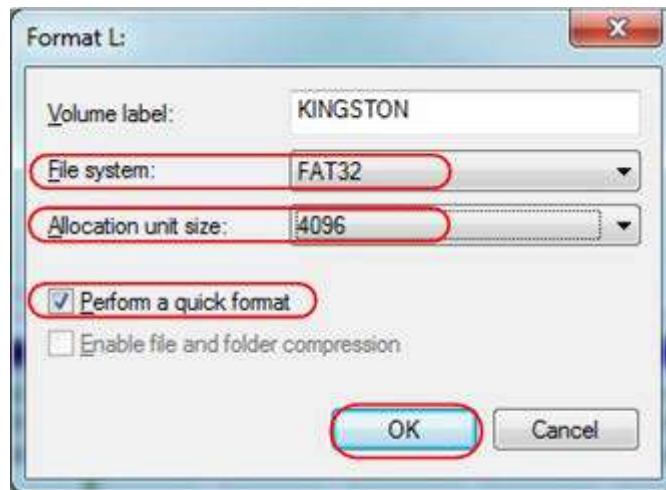

Figure 5-41: Formatting the USB disk setting

- Formatting process.

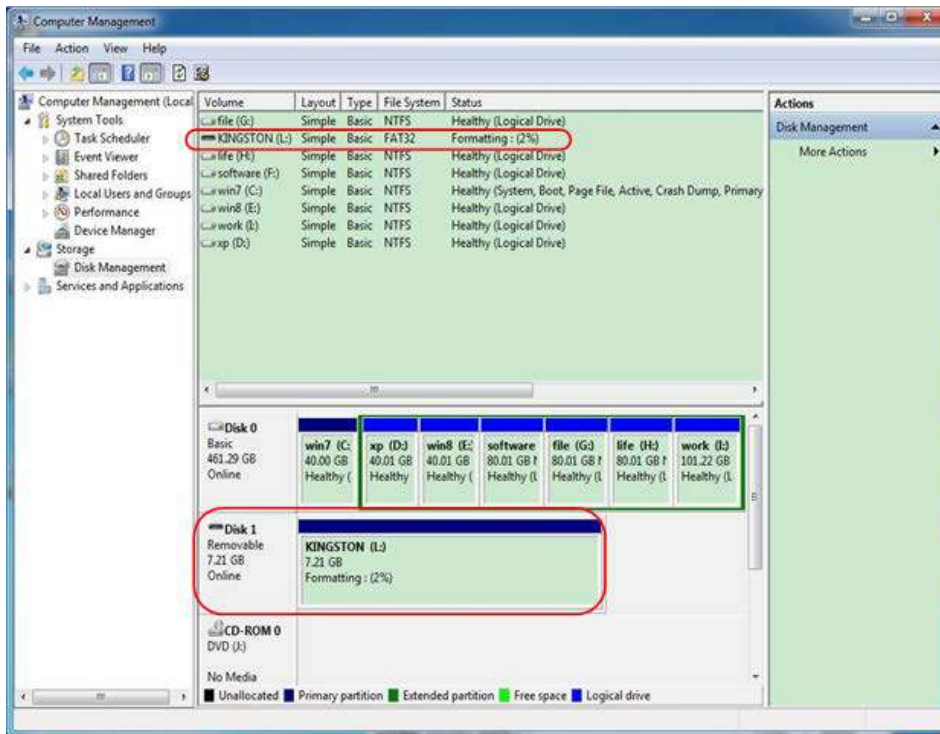

Figure 5-42: Formatting the USB disk

7. Check whether the USB disk is FAT32 with allocation unit size 4096 after formatting.

## Use Minitool Partition Wizard to format

Download URL: <http://www.partitionwizard.com/free-partition-manager.html>

**Tip:** There are many tools for the USB disk formatting on the market, just take Minitool Partition Wizard for example here.

1. Connect the USB disk to the computer.
2. Open the software **Minitool Partition Wizard**.
3. Click **Reload Disk** on the pull-down menu at the top left or press keyboard F5, and information about the USB disk will display on the right side with red mark 1 and 2.

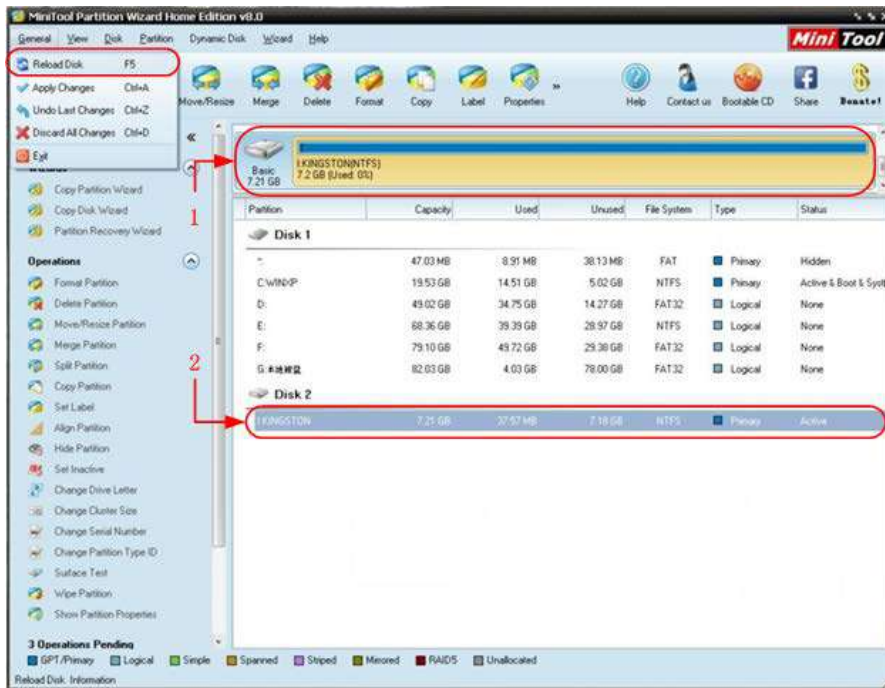

Figure 5-43: Reload Disk

- Right click 1 or 2 red mark area, choose **Format**.

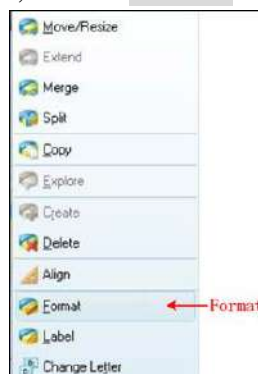

Figure 5-44: Choose format

- Set File System FAT32, Cluster size 4096. Click **OK**.

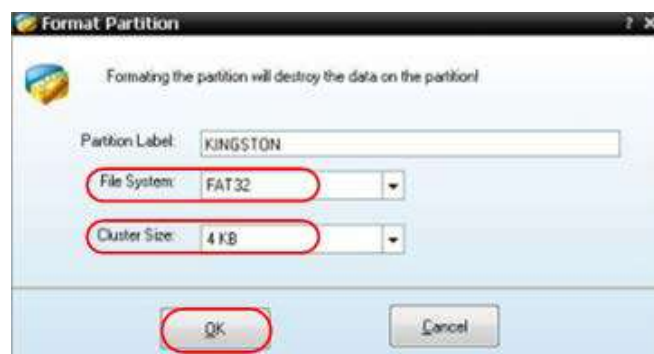

Figure 5-45: Format setting

- Click **Apply** at the top left of the menu. Then click **Yes** on the pop-up warning to begin formatting.



Figure 5-46: Apply setting

7. Formatting process



Figure 5-47: Format process

8. Format the USB disk successfully



Figure 5-48: Format successfully

## How to Cut and Recall a waveform

To cut waveform between two time cursors, generate a file with the suffix “\*.ota”, and save it to external memory device. To recall the waveform is to use AG1022F or AG2052F manufactured by OWON to read \*.ota and recall the waveform being cut from oscilloscope.

### To cut waveform:

1. Connect U-disk to the oscilloscope

2. Press **Save** to call out the save menu
3. Press the **H1** button, the type menu will display at the left of the screen, turn the M knob to choose **Cut Wave** for type.
4. Move cursor1 (CH1 zero position knob) and cursor2 (CH2 zero position knob) to choose the range of wave to be cut.
5. Press the **H2** button, and the input keyboard will pop up. The default name is the current system date. Turn M knob to choose the keys, and press M knob to input the chosen keys. Choose and press **Enter** key of the keyboard to end the input and store the file with the current name to U-disk.

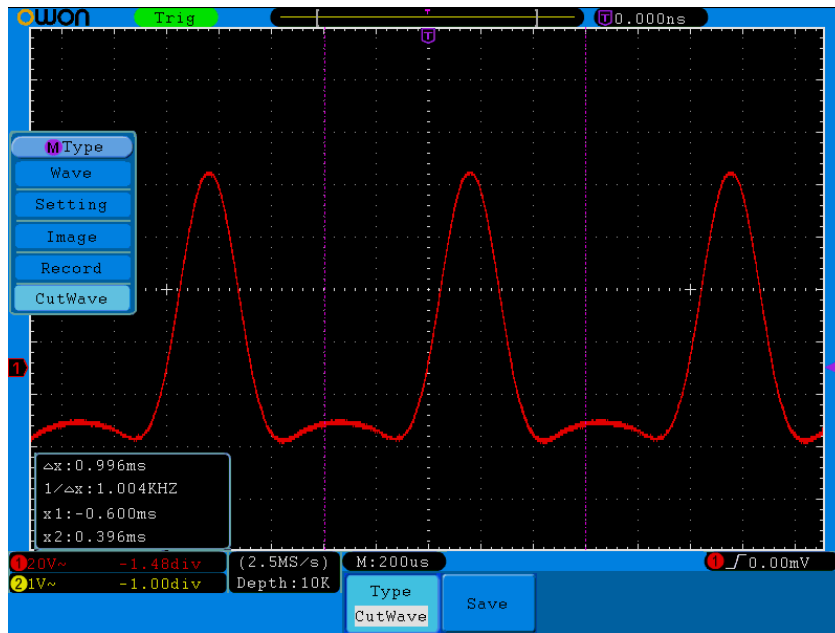

Figure 5-49: Cut Wave

**To recall waveform:**

- (1) **Enter the operation menu:** Press  → **Editable Wform** → **SelectWform**.

Enter the following interface:

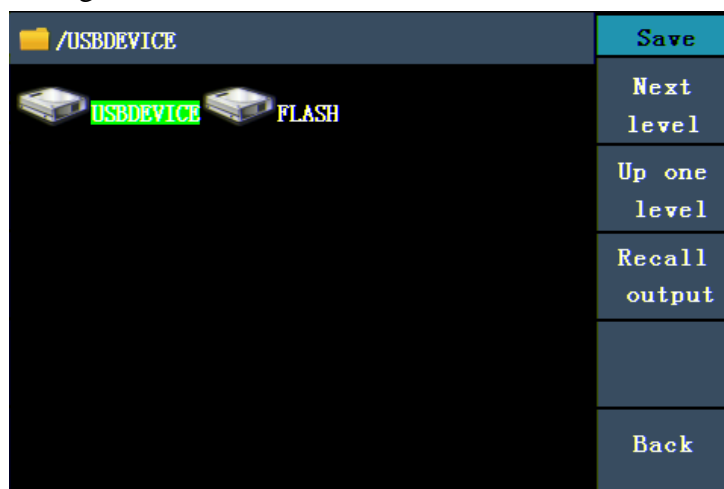

Figure 5-50: Choose storage device

- (2) Select **USBDEVICE**, enter **Next Level**. Turn the **knob** or press **◀/▶** direction key to select the saved **example.ota** waveform file.

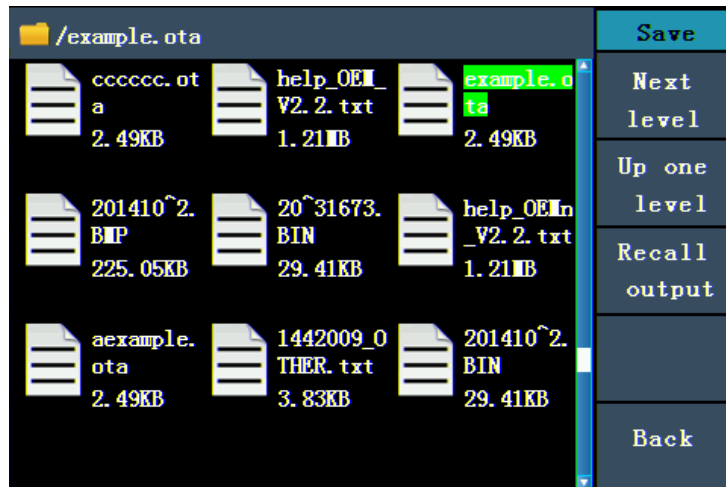

Figure 5-51: choose the .ota file

- (3) Choose **Recall output**. And the tip “Read file successfully” will show on the interface.

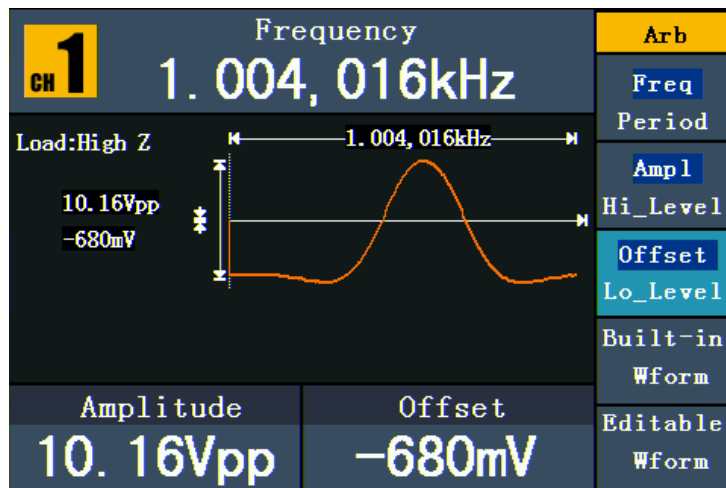

Figure 5-52: Read file

**Tips:**

1. Normally the frequency, amplitude, and offset of the recalled wave are the same as the wave being cut, but when the frequency, amplitude, and offset are set out of the limit range, then AG generators would use the current parameter, which leads to the recalled wave not totally the same as the cut wave.
2. The max data number of AG1022F ARB is 8192. When the wave cut from oscilloscope contains data number more than 8192, AG1022 will compress data. On the contrary if the data number is less than 8192, AG1022F will use linear interpolation.
3. The max data number of AG2052F ARB is 1000000. When the wave cut from oscilloscope contains data number more than 1000000, AG2052F will compress data. On the contrary if the data number is less than 1000000, AG2052F will use linear interpolation.



## How to Record/Playback Waveforms

Wave Record function can record the input current wave. You can set the interval between recorded frames in the range of 1 ms - 1000 s. The max frame number reaches 1000, and you can get better analysis effect with playback and storage function. The storage medium contains two kinds: Internal and External.

When the storage medium is Internal, Wave Record contains four modes: **OFF**, **Record**, **Playback** and **Storage**.

When storage medium is External (See P63 Wave Record Menu of External Storage), Wave Record contains two modes: **OFF**, **Record**.

**Record:** To record wave according to the interval until it reaches the end frame set.

Record menu (Internal Storage) shows as follows:

Menu	Setting	Instruction
Mode	OFF	Close wave record function
	Record	Set record menu
	Playback	Set playback menu
	Storage	Set storage menu
Record mode FrameSet	End frame	Turn the <b>M</b> knob to select the number of frames to record (1 - 1000)
	Interval	Turn the <b>M</b> knob to select the interval between recorded frames (1ms - 1000s)
Refresh	ON	Refresh wave during recording
	OFF	Stop refreshing
Operate	Play	Begin to record
	Stop	Stop recording

**Note:**

Both of the waveforms of Channel 1 and Channel 2 will be recorded. If a Channel is turned off while recording, the waveform of the channel is invalid in the playback mode.

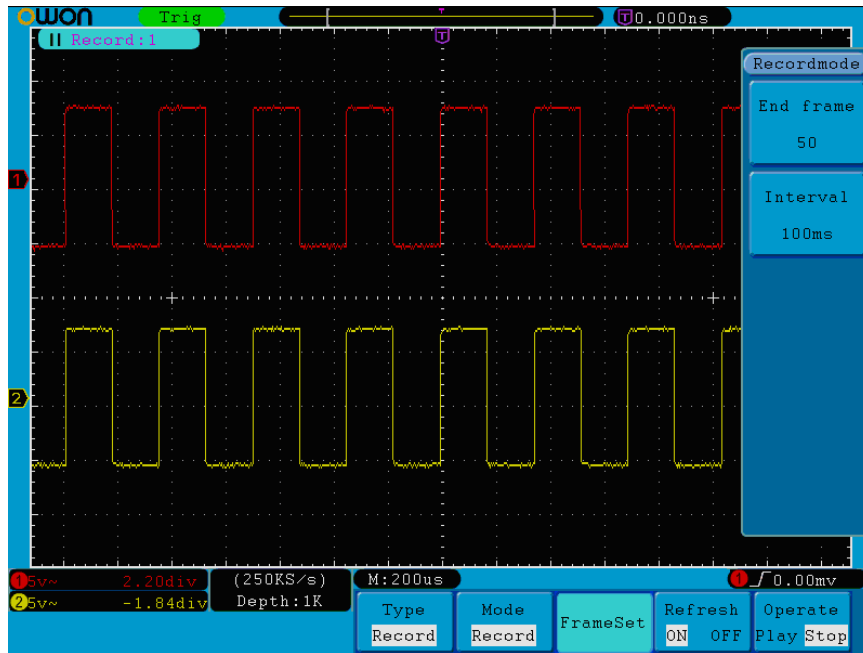

Figure 5-53 Wave Record

**Playback:** Play back the wave recorded or saved.

Playback menu shows as follows:

Menu	Setting	Instruction
Playback Mode FrameSet	Start frame	Turn the <b>M</b> knob to select the number of start frame to playback (1 - 1000)
	End frame	Turn the <b>M</b> knob to select the number of end frame to playback (1 - 1000)
	Cur frame	Turn the <b>M</b> knob to select the number of current frame to playback (1 - 1000)
	Interval	Turn the <b>M</b> knob to select the interval between played back frames (1ms - 1000s)
Play mode	Loop	Play back the wave continuously
	Once	Play back the wave just one time
Operate	Play	Begin to record
	Stop	Stop recording

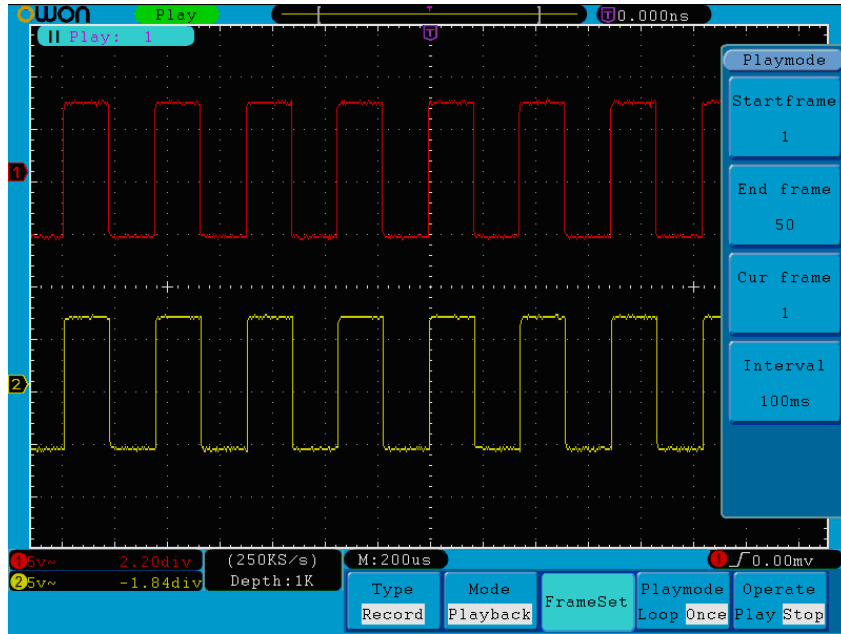

Figure 5-54 Wave Playback

**Storage:** Save the current wave according to the start frame and end frame set. Storage menu shows as follows:

Menu	Setting	Instruction
Storage Mode Frame Set	Start frame	Turn the <b>M</b> knob to select the number of start frame to store (1 - 1000)
	End frame	Turn the <b>M</b> knob to select the number of end frame to store (1 - 1000)
Save		Save the waveform record file to the internal memory
Load		Load the waveform record file from the memory

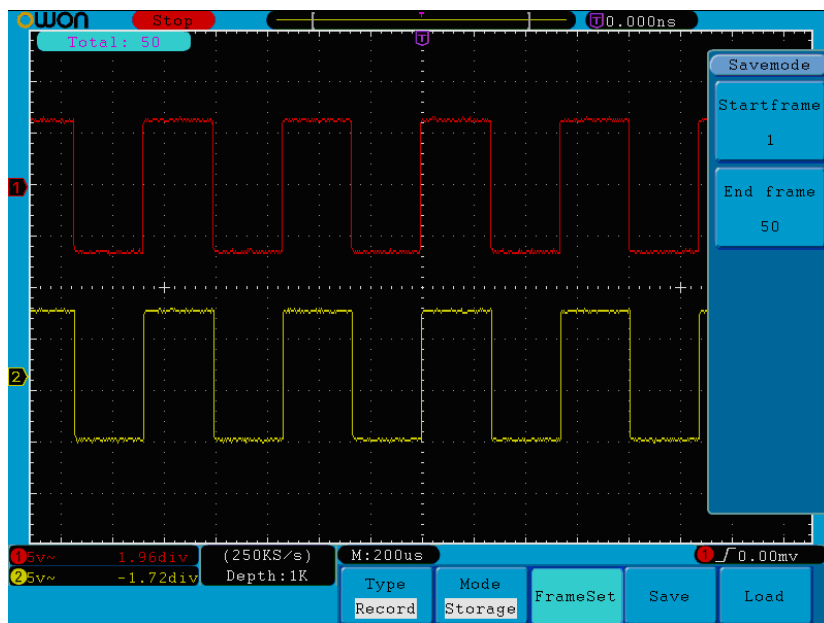

Figure 5-55 Wave Storage

To use wave record function, do as follows:

- (1) Press **Save** button.
- (2) Press **H1** button, turn the **M** knob to choose **Record**.
- (3) Press **H2** button. In the Mode menu, press **F2** button to choose **Record**.
- (4) Press **H3** button. In the Frame Set menu, press **F1** button and turn the **M** knob to set End frame; press **F2** button and turn the **M** knob to select the interval between recorded frames.
- (5) Press **H4** button, choose whether to refresh the wave when recording.
- (6) Press **H5** button to start recording.
- (7) Press **H2** button. In the Mode menu, press **F3** button to enter the **Playback** mode. Set the frame range and **Playmode** .Then, press **H5** button to play.
- (8) To save the wave recorded, press **H2** button. In the Mode menu, press **F4** button to choose **Storage**, then set the range of frames to store, press **H4** button to save.
- (9) To load the waveform from the internal memory, press **Load**, and then enter playback mode to analyze the wave.

**When storage medium is External, Wave Record contains two modes: OFF, Record.**

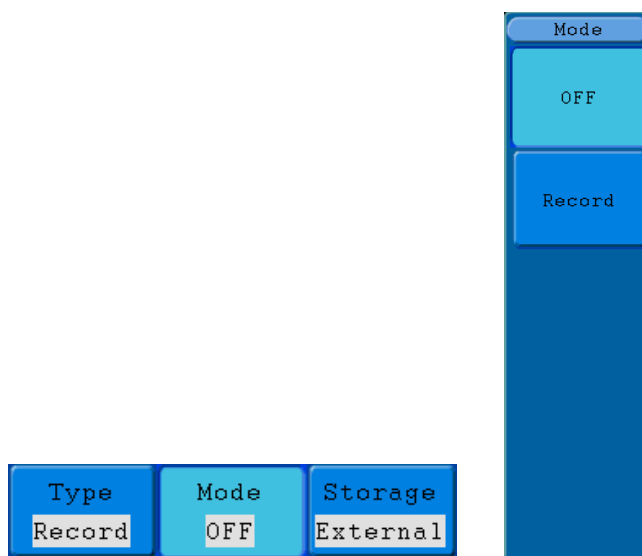

Figure 5-56: Wave Record Menu of External Storage

Record menu (External Storage) shows as follows:

Menu	Setting	Instruction
Mode	OFF	Close wave record function
	Record	Set record menu
Record mode FrameSet	End frame	Turn the <b>M</b> knob to select the number of frames to record (1 - 1000)
	Interval	Turn the <b>M</b> knob to select the interval between recorded frames (1ms - 1000s)
	Infinity	Record infinitely until the storage medium is full
Refresh	ON	Refresh wave during recording
	OFF	Stop refreshing

Operate	Play Stop	Begin to record Stop recording
---------	--------------	-----------------------------------

**Note:**

Both of the waveforms of Channel 1 and Channel 2 will be recorded. If a Channel is turned off while recording, the waveform of the channel is invalid in the playback mode.

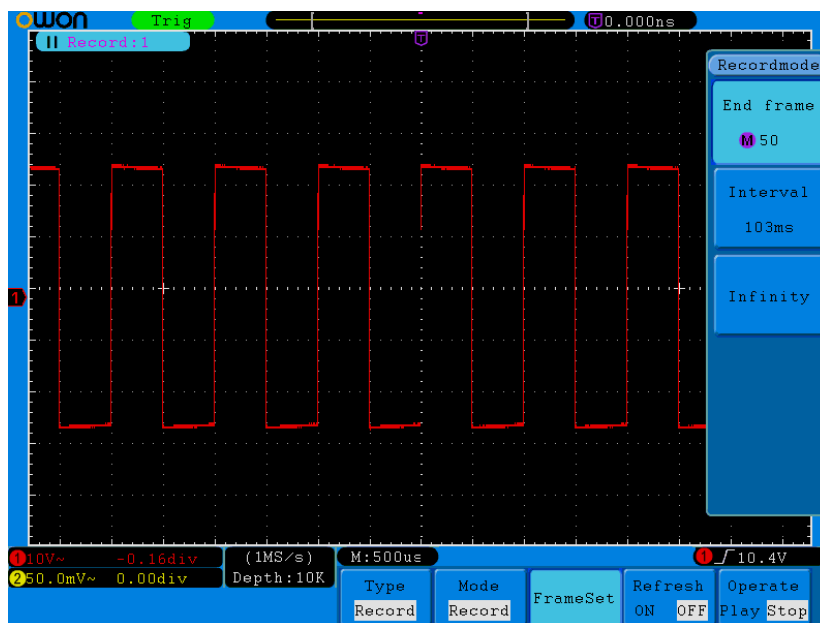

Figure 5-57: Frame setting (External Storage)

To use wave record to external, do as follows:

1. Press **Save** button.
2. Press **H1** button, turn the **M** knob to choose **Record**.
3. Press **H2** button. In the Mode menu, press **F2** button to choose **Record**. Press **H3** to choose **External** as the storage medium.
4. Press **H3** button. In the Frame Set menu, press **F1** button and turn the **M** knob to set End frame; press **F2** button and turn the **M** knob to select the interval between recorded frames. Press **F3** to wave record to external infinitely if necessary, and end frame will display “-”.
5. Press **H4** button, choose whether to refresh the wave when recording.
6. Press **H5** button to start recording.

**Connect external device to the computer, and `wave_record_0.bin` is the recorded file. Open the software, and do as follows to play back the waveform.**

1. Choose **Communications** → **Auto Player**.
2. Transform recording waveform from machine.
3. Add the well transformed files.
4. Set play mode and time delay.
5. Click the green button on the left corner to begin playing back the waveform.

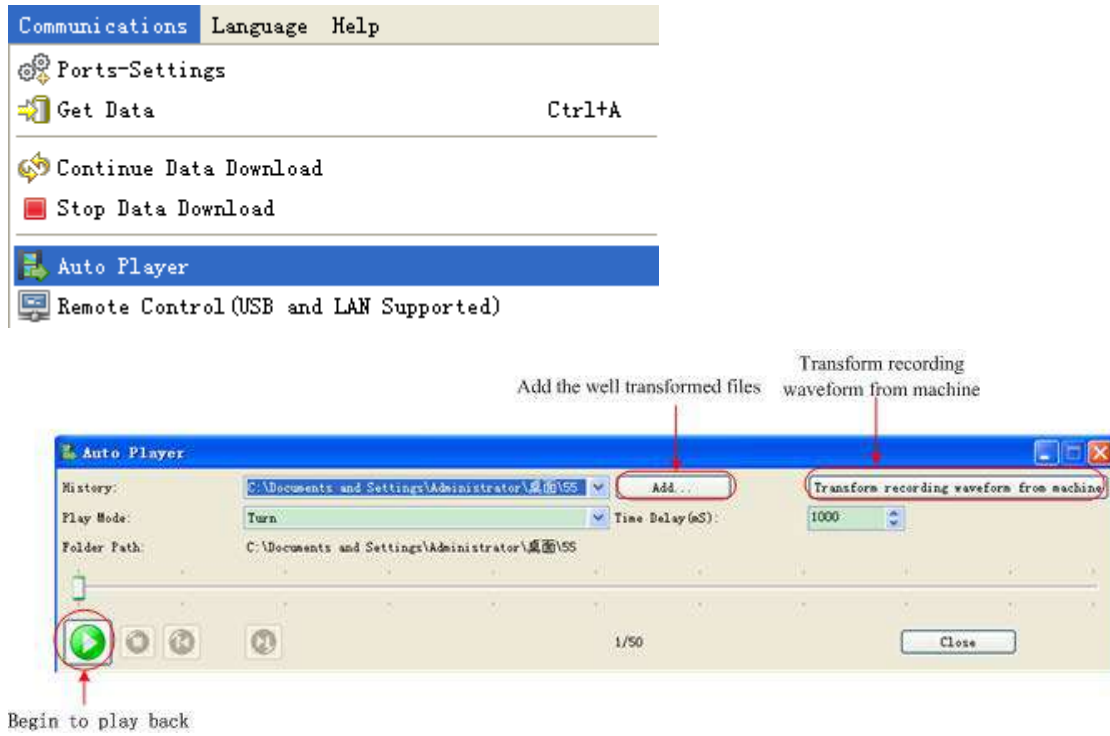

Figure 5-58: Play back waveform by software

## How to Implement the Auxiliary System Function Setting

### ● Config

Press the **Utility** button and turn the **M** knob to select **Config** to go to the following menu.

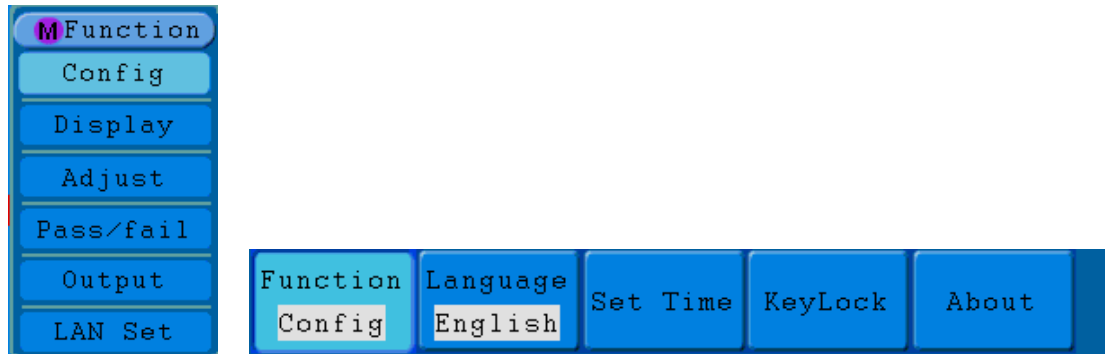

Figure 5-59 Configuration Menu

The description of **Configuration Menu** is shown as the follows:

Function Menu	Setting	Description
Language	Chinese English Others	Choose the display language of the operating system.
Set Time	Display   On Off	On/Off the date display
	Hour   Min	Setting Hour/Minute
	Day   Month	Setting Date/Month
	Year	Setting Year
KeyLock		Lock all keys. Unlock method: press <b>50%</b> button in trigger control area, then press <b>Force</b> button, repeat 3 times.
About		Version number and serial number showing

●Display

Press the **Utility** button and turn the **M** knob to select the **Display** to go to the following menu.



Figure 5-60 Display Menu

The description of **Display Menu** is shown as the follows:

Function Menu	Setting	Description
BackLight	0% - 100%	Turn the <b>M</b> knob to adjust the backlight.
Graticule		Select the grid type
Battery	ON OFF	Turn on or off the battery display
Menu Time	5s - 50s, OFF	Set the disappear time of menu

●Adjust

Press the **Utility** button and turn the **M** knob to select the **Adjust** to go to the following menu.



Figure 5-61 Adjust Menu

The description of **Adjust Menu** is shown as the follows:

Function Menu	Setting	Description
Self Cal		Carry out the self-calibration procedure.
Default		Call out the factory settings.
ProbeCh.		Check whether probe attenuation is good.

### Do Self Cal (Self-Calibration)

The self-calibration procedure can improve the accuracy of the oscilloscope under the ambient temperature to the greatest extent. If the change of the ambient temperature is up to or exceeds 5°C, the self-calibration procedure should be executed to obtain the highest level of accuracy.

Before executing the self-calibration procedure, disconnect the probe or wire and the input connector. Press the **Utility** button. Then, press the **H1** button and the function menu will display at the left of the screen, turn the **M** knob to choose "**Adjust**", and then press the **H2** button to choose "**Self Cal**", entering the self-calibration procedure of the instrument.

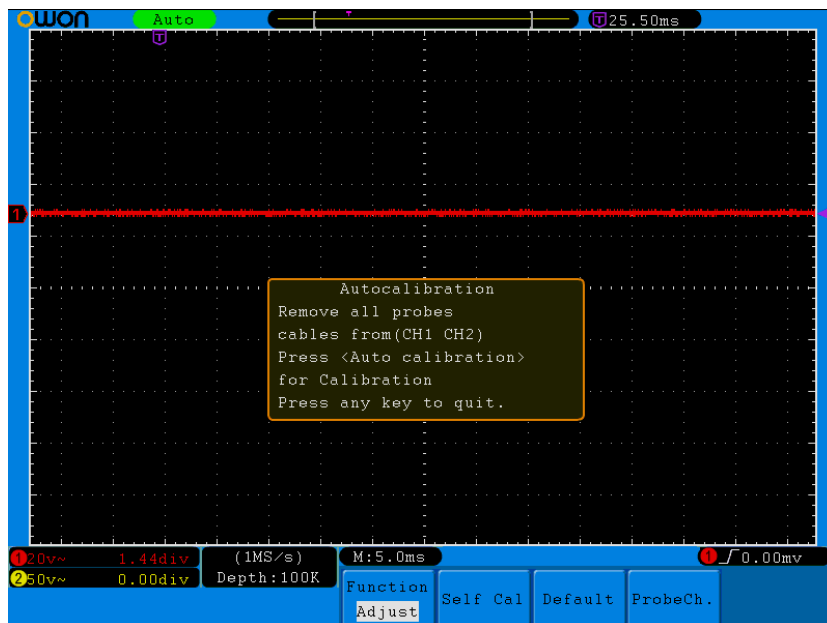

Figure 5-62 Self-Calibration

### Probe checking:

To check whether probe attenuation is good. The results contain 3 circumstances: Overflow compensation, Good compensation, Inadequate compensation. According to the checking result, users can adjust probe attenuation to the best. Operation steps are as follows:

1. Connect the probe to CH1, adjust the probe attenuation to the maximum.
2. Press **Utility** menu, press **H1** and the function menu will display at the left of the screen, turn the **M** knob to choose "Adjust", "**ProbeCh.**" shows at the bottom menu;
3. Press **H4** , choose "**ProbeCh.**", tips about probe checking shows on the screen;



- Press **H4** again to begin probe checking and the checking result will occur after 3s; Press any other key to quit.

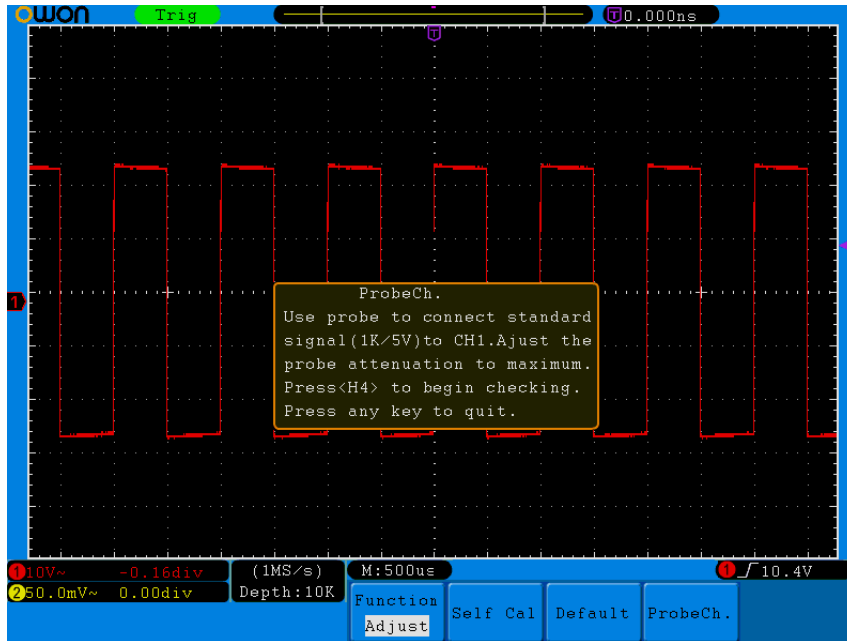

Figure 5-63: Probe Checking

- **Pass/Fail**

The **Pass/Fail** function monitors changes of signals and output pass or fail signals by comparing the input signal that is within the pre-defined mask.

Press the **Utility** button and turn the **M** knob to select the **Pass/fail** to go to the following menu.

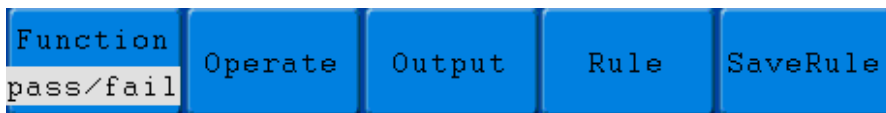

Figure 5-64 Pass/Fail menu

The description of **Pass/Fail Menu** is shown as the follows:

Function Menu	Setting	Description
operate	Enable	Control enable switch
	Operate	Control operate switch
Output	Pass	Signal tested corresponds with the rule
	Fail	Signal tested not correspond with the rule
	Beep	Beep when it satisfies the rule
	Stop	Stop once satisfying the rule
	Info	Control the display status of info frame
Rule	Source	Select source CH1, CH2 or Math
	Horizontal	Change the Horizontal tolerance value by turning the <b>M</b> knob
	Vertical	Change the Vertical tolerance value by turning the <b>M</b> knob
	Create	Use the rule set as testing rule
SaveRule	Number	Choose any one from Rule1 - Rule8 as your rule name
	Save	Click Save to save the rule
	Load	Load some rule as the testing rule

#### **Pass/Fail test:**

Detect whether the input signal is within the limits of the rule, if it exceeds limits of the rule, it is "Fail"; otherwise it is "Pass". Also it can output fail or pass signal by built-in and configurable output port. To run the test, read the following steps:

1. Press **Utility** button, then **H1** button, turn the **M** knob to choose **Pass/fail** menu option, Pass/Fail menu will be displayed in the bottom.
2. **Enable switch on:** Press **H2** button to show **Operate** menu, then, press **F1** button to set **Enable** as **ON**.
3. **Create rule:** Press **H4** button to enter **Rule** setting menu. Press **F1** button to choose the source; Press **F2** button, turn the **M** knob to set Horizontal tolerance; Press **F3** button, turn the **M** knob to set Vertical tolerance; Press **F4** button to create the rule.
4. **Set output type:** Press **H3** button to enter **Output** option setting. Choose any one or two of the options "**Pass**", "**Fail**" or "**Beep**". "**Pass**" and "**Fail**" are mutually exclusive options, which could not be chosen simultaneously. "**Stop**" means stop once the condition satisfies your setting.
5. **Begin to test:** Press **H2** button, then **F2** button to select "**Start**", the test will begin.
6. **Save rule:** Press **H5** button, then **F2** button to save the rules, which could be called up at once when need, press **F3** button to call up the rule saved.

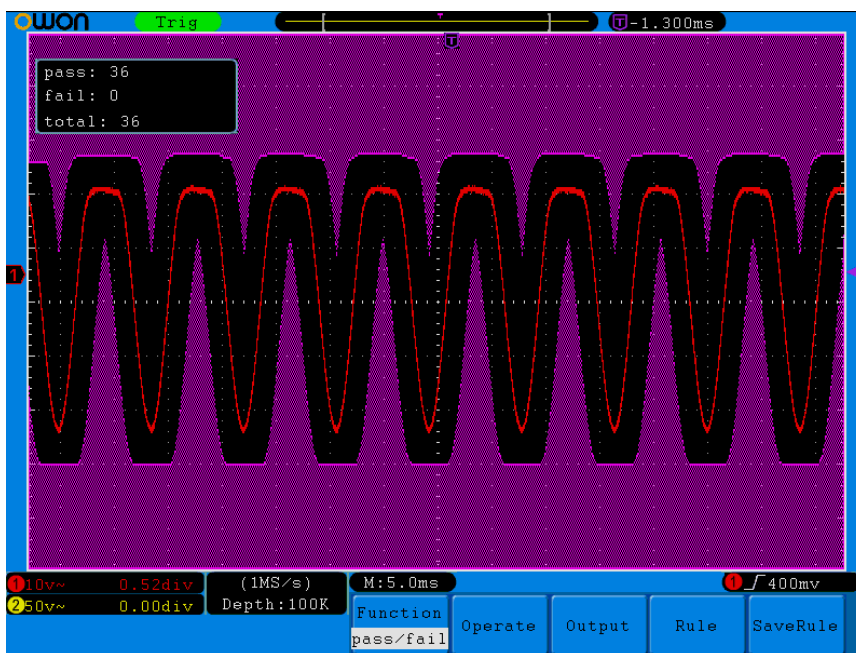

Figure 5-65 Pass/Fail test

**Note:**

1. When Pass/Fail is ON, if XY or FFT is ready to run, then Pass/Fail will be closed; under the mode of XY or FFT, Pass/Fail is unable.
2. Under the mode of Factory, Auto Scale and Auto Set, Pass/Fail will be closed.
3. When no save setting left in the rule save, tip will be given to show "NO RULE SAVED".
4. Under the status of stop, data comparing will stop, and when it goes on running, the number of Pass/Fail will increase from the former number, not from zero.
5. When the waveform playback mode is on, Pass/Fail is used to test the played-back waveform specially.

● **Output**

Press the **Utility** button and turn the **M** to select the **Output** to go to the following menu.



Figure 5-66 Output menu

The description of **Output menu** is shown as the follows:

Function Menu	Setting	Description
Type	Trig level Pass/fail	Output trig signal synchronously Output High Level when Pass , and Low Level when Fail

● **LAN Set**

Using the LAN port, the oscilloscope can be connected with a computer directly, or through the router to connect. The network parameters can be set in the menu below. Refer to "Using LAN Port" on P85 for the operation steps.

Press the **Utility** button and turn the **M** knob to select the **LAN Set** to go to the following menu.

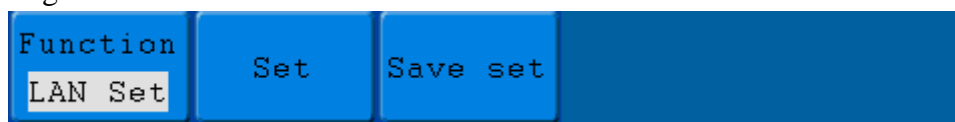

Figure 5-67 LAN Set menu

The description of **LAN Set menu** is shown as the follows:

Function Menu	Setting	Description
Set	IP	Press <b>F1</b> button to switch between each byte, turn the <b>M</b> knob to change value (0 - 255)
	Port	Turn the <b>M</b> knob to change value (0 - 4000)
	Netgate	Press <b>F3</b> button to switch between each byte, turn the <b>M</b> knob to change value (0 - 255)
	Phy addr	Press <b>F4</b> button to switch between each byte, turn the <b>M</b> knob to change value (0 - FF)
	Net mask	Press <b>F5</b> button to switch between each byte, turn the <b>M</b> knob to change value (0 - 255)
Save set	Save the current settings and prompt "reset to update the config"	

● **Signal** (Only SDS7072(V) has this menu)

You can adjust the signal parameters of "5. Probe Compensation" in Figure 4-1 Front panel.

Press the **Utility** button and turn the **M** knob to select the **Signal** to go to the following menu.



Figure 5-68 Signal menu

The description of **Signal menu** is shown as the follows:

Function Menu	Setting	Description
Set	Frequency	Turn the <b>M</b> knob to change value (1KHz - 100KHz)
	Duty	Turn the <b>M</b> knob to change value (5% - 95%)
	Reset	Set Frequency to 1KHz, set Duty to 50%

## How to Measure Automatically

Press the **Measure** button to display the menu for the settings of the Automatic Measurements. At most 8 types of measurements could be displayed on the bottom left of the screen.

The oscilloscopes provide 24 parameters for auto measurement, including Period, Freq, Mean, PK-PK, RMS, Max, Min, Vtop, Vbase, Vamp, OverShoot, PreShoot, Rise Time, Fall Time, +D width, -D width, +Duty, -Duty, Delay A→B  $\overline{\Psi}$ , Delay A→B  $\overline{\Psi}$ , Cycle RMS, Cursor RMS, Duty cycle, and Phase.

The menu is displayed as *Figure 5-69*.

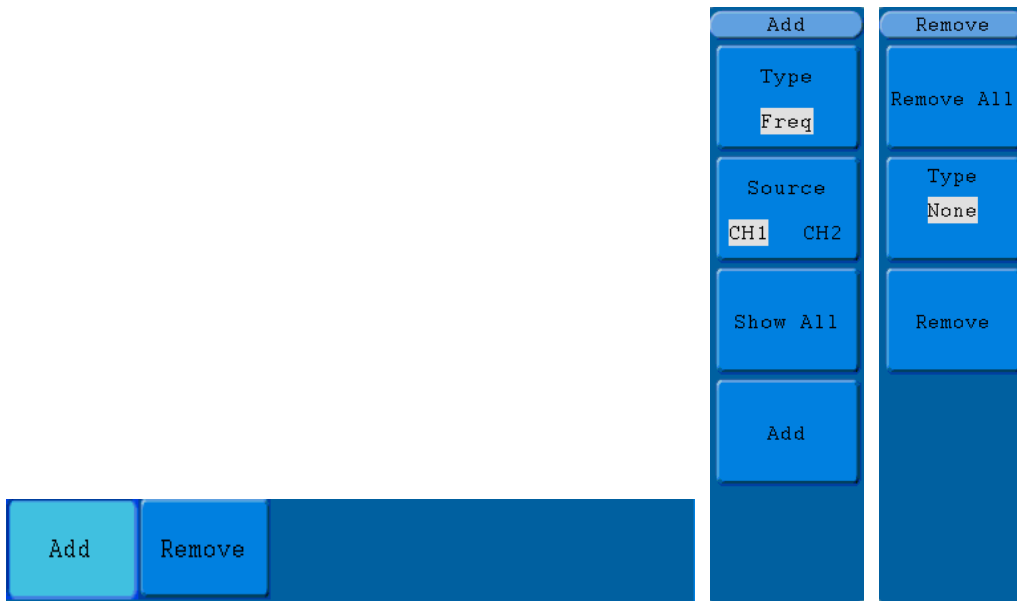

Figure 5-69 Measure Menu

The "Automatic Measurements" menu is described as the following table:

Function	Menu	Setting	Description
Add	Type		Press F1 ,show the measure types
	Source	CH1	Select the source
		CH2	
	Show all		Show all the measures on the screen
Add		Add the selected measure types (shown at the left bottom, you could only add 8 types at most)	
Remove	Remove all		Remove all the measures
	Type		Turn the <b>M</b> knob, select the types need to be deleted.
	Remove		Remove the chosen measure type

### Measure

The measured values can be detected on each channel simultaneously. Only if the

waveform channel is in the ON state, the measurement can be performed. The automatic measurement cannot be performed in the following situation: 1) On the saved waveform. 2) On the mathematical waveform. 3) On the XY format. 4) On the Scan format.

Measure the period, the frequency of the CH1 and the mean, the peak-to-peak voltage of the CH2, following the steps below:

1. Press the **Measure** button to show the automatic measurement function menu.
2. Press the **H1** button to display the **Add** menu.
3. Press the **F2** button and choose **CH1** as the source.
4. Press the **F1** button, the type items will display at the left of screen, and turn the **M** knob to choose **Period**.
5. Press the **F4** button, the period options added completes.
6. Press the **F1** button again, the type items will display at the left of screen, and turn the **M** knob to choose **Freq**.
7. Press the **F4** button, the frequency added completes, finish setting of CH1.
8. Press the **F2** button and choose **CH2** as the source.
9. Press the **F1** button, the type items will display at the left of screen, and turn the **M** knob to choose **Mean**.
10. Press the **F4** button, the Mean added completes.
11. Press the **F1** button, the type items will display at the left of screen, and turn the **M** knob to choose **PK-PK**.
12. Press the **F4** button, the PK-PK added completes, finish setting of CH2.

The measured value will be displayed at the bottom left of the screen automatically (see *Figure 5-70*).

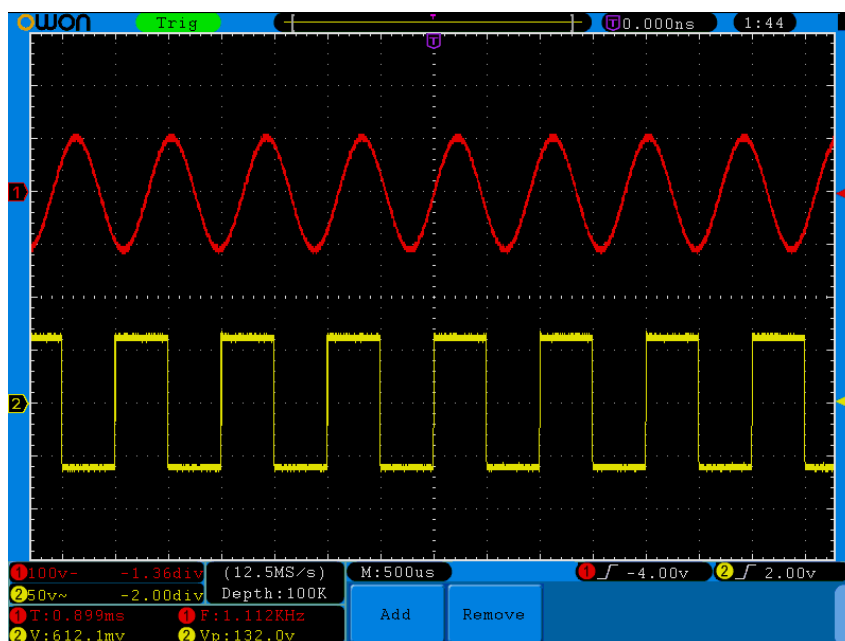

Figure 5-70 automatic measurement

### The automatic measurement of voltage parameters

The oscilloscopes provide automatic voltage measurements including Mean, PK-PK, RMS, Max, Min, Vtop, Vbase, Vamp, OverShoot, PreShoot, Cycle RMS, and Cursor RMS. *Figure 5-71* below shows a pulse with some of the voltage measurement points.

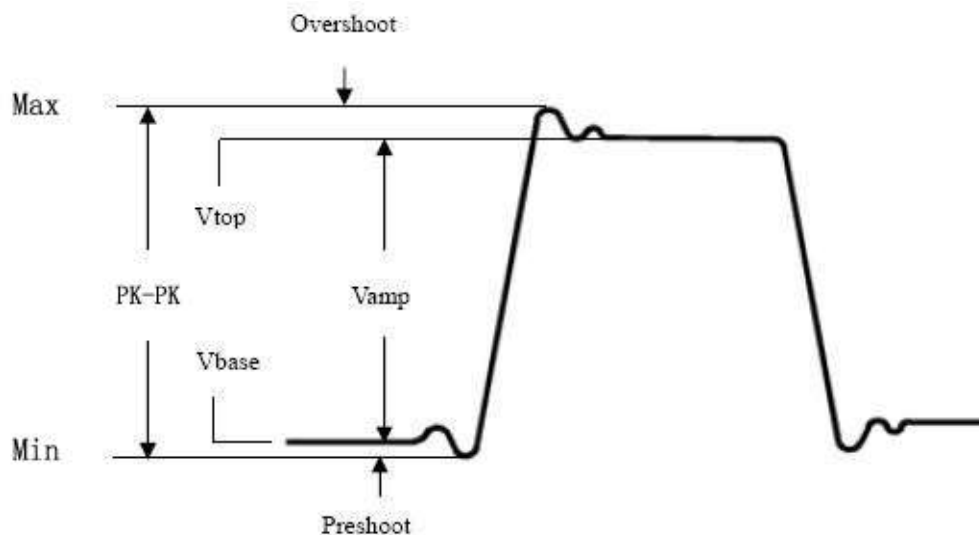

Figure 5-71

**Mean:** The arithmetic mean over the entire waveform.

**PK-PK:** Peak-to-Peak Voltage.

**RMS:** The true Root Mean Square voltage over the entire waveform.

**Max:** The maximum amplitude. The most positive peak voltage measured over the entire waveform.

**Min:** The minimum amplitude. The most negative peak voltage measured over the entire waveform.

**Vtop:** Voltage of the waveform's flat top, useful for square/pulse waveforms.

**Vbase:** Voltage of the waveform's flat base, useful for square/pulse waveforms.

**Vamp:** Voltage between Vtop and Vbase of a waveform.

**OverShoot:** Defined as  $(V_{max} - V_{top}) / V_{amp}$ , useful for square and pulse waveforms.

**PreShoot:** Defined as  $(V_{min} - V_{base}) / V_{amp}$ , useful for square and pulse waveforms.

**Cycle RMS:** The true Root Mean Square voltage over the first entire period of the waveform.

**Cursor RMS:** The true Root Mean Square voltage over the range of two cursors.

### The automatic measurement of time parameters

The oscilloscopes provide time parameters auto-measurements include Period, Frequency, Rise Time, Fall Time, +D width, -D width, +Duty, -Duty, Delay

$A \rightarrow B \text{ } \Phi$ , Delay  $A \rightarrow B \text{ } \Psi$ , and Duty cycle.

Figure 5-72 shows a pulse with some of the time measurement points.

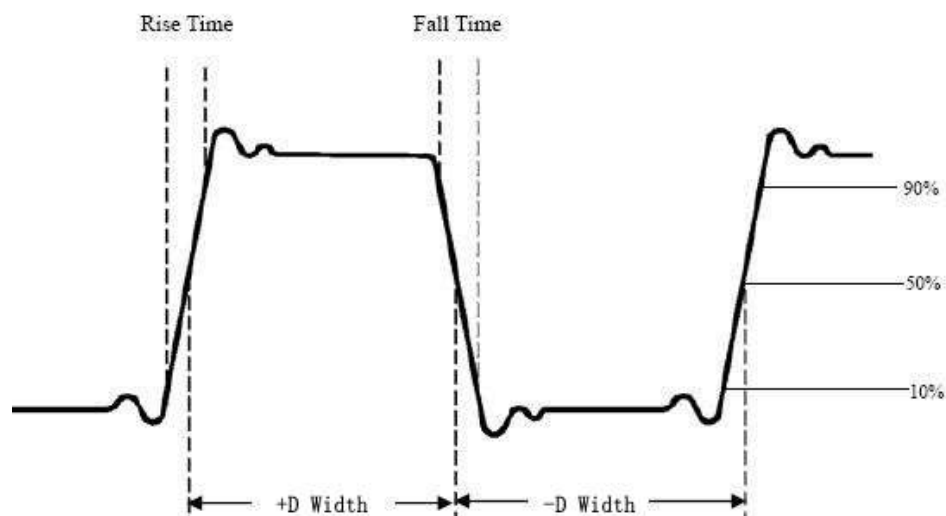

Figure 5-72

**Rise Time:** Time that the leading edge of the first pulse in the waveform takes to rise from 10% to 90% of its amplitude.

**Fall Time:** Time that the falling edge of the first pulse in the waveform takes to fall from 90% to 10% of its amplitude.

**+D width:** The width of the first positive pulse in 50% amplitude points.

**-D width:** The width of the first negative pulse in the 50% amplitude points.

**+Duty:** +Duty Cycle, defined as +Width/Period.

**-Duty:** -Duty Cycle, defined as -Width/Period.

**Delay  $A \rightarrow B \text{ } \Phi$ :** The delay between the two channels at the rising edge.

**Delay  $A \rightarrow B \text{ } \Psi$ :** The delay between the two channels at the falling edge.

**Duty cycle:** Defines as (the width of the positive pulse)/(Entire period)

### The phase difference of two channels:

**Phase:** Compare the rising edge of CH1 and CH2, calculate phase difference of two channels.

Phase difference = [ (Delay between channels at the rising edge)\*PI]/Period.

### How to Measure with Cursors

Press the **Cursor** button to display the cursor measurement function menu (**CURS MEAS**) in the screen.

#### The Cursor Measurement for normal mode:

The cursor measurement includes **Voltage Measurement** and **Time Measurement**



at normal mode, shown as *Figure 5-73*.



Figure 5-73 CURS MEAS Menu

The description of the **cursor measurement menu** is shown as the following table:

Function Menu	Setting	Description
Type	OFF	Switch off the cursor measurement.
	Voltage	Display the voltage measurement cursor and menu.
	Time	Display the time measurement cursor and menu.
Source	CH1	Display the channel generating the waveform to which the cursor measurement will be applied.
	CH2	

When carrying out the cursor measurement, the position of Cursor 1 can be adjusted with the **VERTICAL POSITION** knob of Channel 1, and that of Cursor 2 can be adjusted with the **VERTICAL POSITION** knob of Channel 2.

Perform the following operation steps for the voltage cursor measurement of the channel CH1:

1. Press **Cursor** and recall the Cursor Measure menu.
2. Press the **H2** button and choose **CH1** for **Source**.
3. Press the **H1** button, the **Type** menu will display at the right of the screen. Then press the **F2** button to choose **Voltage** for Type, with two purple dotted lines displayed along the horizontal direction of the screen, which indicating Cursor1 and Cursor2.
4. According to the measured waveform, adjust the positions of Cursor1 and Cursor2 by turning the **VERTICAL POSITION** knob of CH1 and CH2. Cursor increment window at the left bottom of waveform shows absolute value of D-value of cursor 1 and cursor 2 and the present position of the two cursors (see *Figure 5-74*).

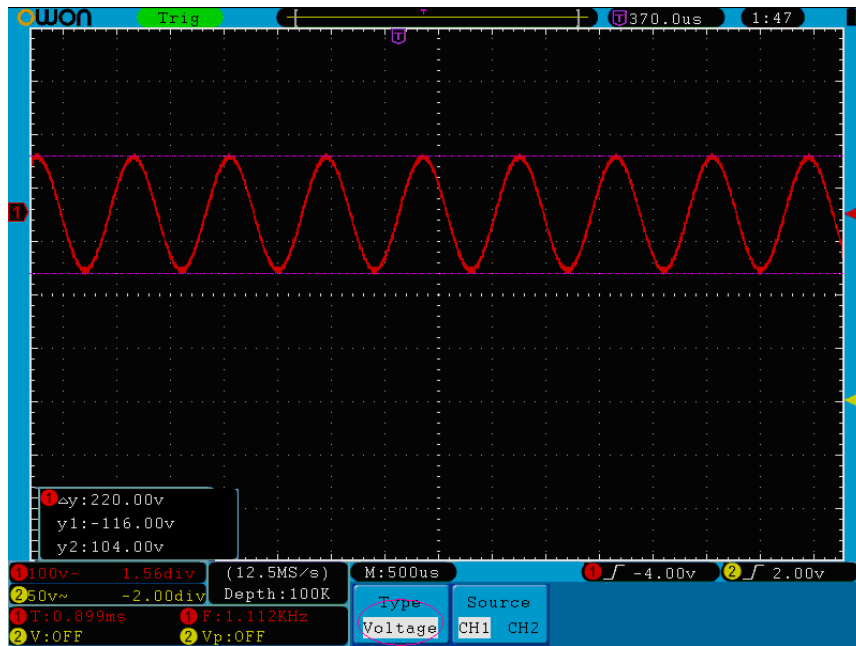

Figure 5-74 Waveform of Voltage Cursor Measurement

Carry out the following operation steps for the time cursor measurement of the channel CH1:

1. Press **Cursor** and recall the Cursor Measure menu.
2. Press the **H2** button and choose **CH1** for **Source**.
3. Press the **H1** button, the **Type** menu will display at the right of the screen. Press the **F3** button to select **Time** for **Type**, with two purple dotted lines displayed along the vertical direction of the screen, which indicating Cursor 1 and Cursor 2.
4. According to the measured waveform, adjust the positions of Cursor1 and Cursor2 by turning the **VERTICAL POSITION** knob of CH1 and CH2. The cursor increment window at the left bottom of the waveform shows absolute difference, frequency and the present time of the two cursors.

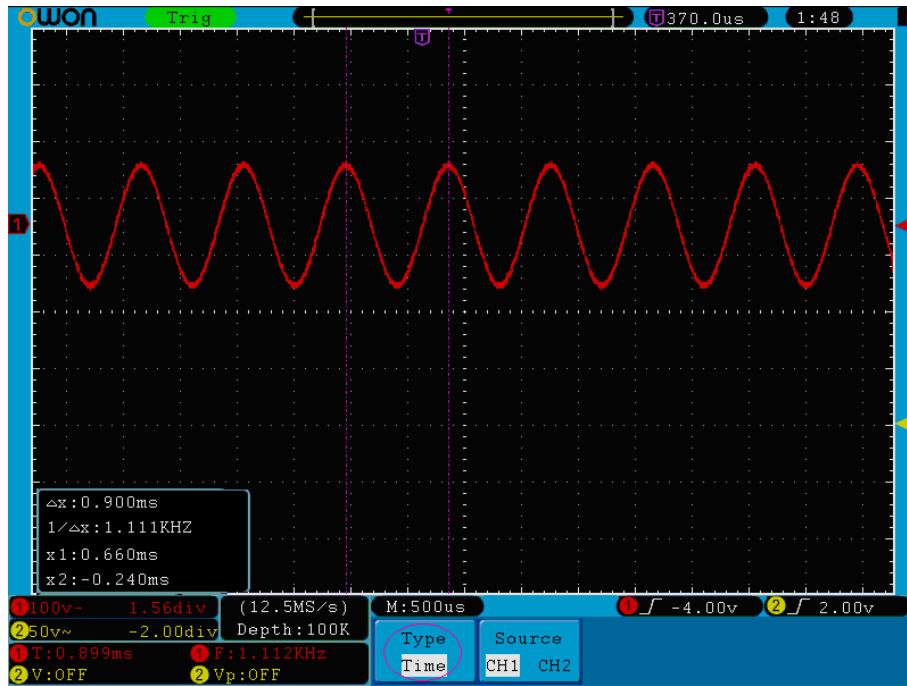

Figure 5-75 Waveform of Cursor Measurement

**The Cursor Measurement for FFT mode:**

Press the **Cursor** button to display the cursor measurement function menu (CURS MEAS) in the screen, which includes **Vamp** Measurement and **Freq** Measurement at the mode of FFT, shown as *Figure 5-76*.



Figure 5-76 CURS MEAS Menu

The description of the cursor measurement menu is shown as the following table:

Function Menu	Setting	Description
Type	OFF	Switch off the cursor measurement.
	Vamp	Display the Vamp measurement cursor and menu.
	Freq	Display the Freq measurement cursor and menu.

Source	Math FFT	Display the channel for the cursor measure.
--------	----------	---

When carrying out the cursor measurement, the position of Cursor 1 can be adjusted with the **VERTICAL POSITION** knob of Channel 1, and that of Cursor 2 can be adjusted with the **VERTICAL POSITION** knob of Channel 2.

Perform the following operation steps for the Vamp cursor measurement:

1. Press **Cursor** and recall the Cursor Measure menu.
2. Press the **H1** button, the **Type** menu will display at the right of the screen. Press the **F2** button to select **Vamp** for **Type**, with two purple dotted lines displayed along the horizontal direction of the screen indicating Cursor1 and Cursor2.
3. According to the measured waveform, adjust the positions of Cursor1 and Cursor2 by turning the **VERTICAL POSITION** knob of CH1 and CH2. Cursor increment window at the left bottom shows absolute value of the two cursors amplitude difference and the present position.

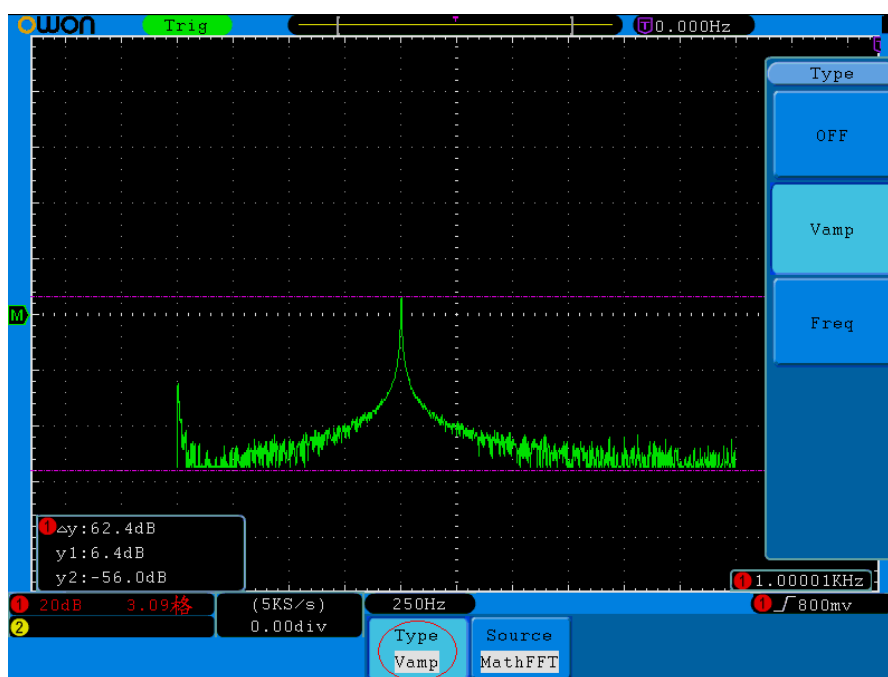

Figure 5-77 wave of Vamp cursor measurement

Carry out the following operation steps for the Freq cursor measurement:

1. Press **Cursor** and recall the Cursor Measure menu.
2. Press the **H1** button, the **Type** menu will display at the right of the screen. Press the **F3** button to select **Freq** for **Type**, with two purple dotted lines displayed along the vertical direction of the screen indicating the corresponding Cursor 1 and Cursor 2.
3. According to the measured waveform, adjust the positions of Cursor1 and

Cursor2 by turning the **VERTICAL POSITION** knob of CH1 and CH2. Increment window shows two cursors difference value and the present position (see Figure 5-78).

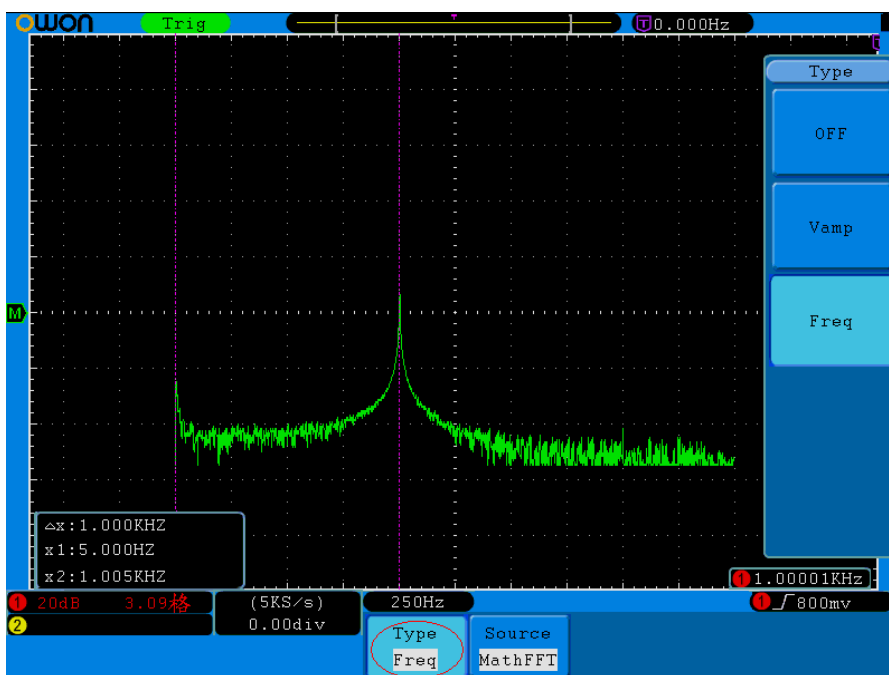

Figure 5-78 wave of Freq cursor measurement

### How to Use Autoscale





This is a very useful function for first time users to carry out a simple and quick test on the input signal. The function is applied to follow-up signals automatically even if the signals change at any time. Autoscale enables the instrument to set up trigger mode, voltage division and time scale automatically according to the type, amplitude and frequency of the signals.





Figure 5-79 Autoscale menu

The menu is as follows:

Function Menu	Setting	Instruction
---------------	---------	-------------

Autoscale	ON OFF	Turn on Autoscale. Turn off Autoscale.
Mode		Follow-up and adjust both vertical and horizontal settings.
		Follow-up and only adjust horizontal scale.
		Follow-up and only adjust vertical scale.
Wave		Show Multi-period waveforms.
		Only show one or two periods.

If you want to measure the two-channel signal, you can do as the follows:

1. Press **Autoscale** button, the function menu will appear.
2. Press **H1** to choose **ON**.
3. Press **H2** and choose  for **Mode** item.
4. Press **H3** and choose  for **Wave** item.

Then the wave is displayed in the screen, shown as *Figure 5-80*.

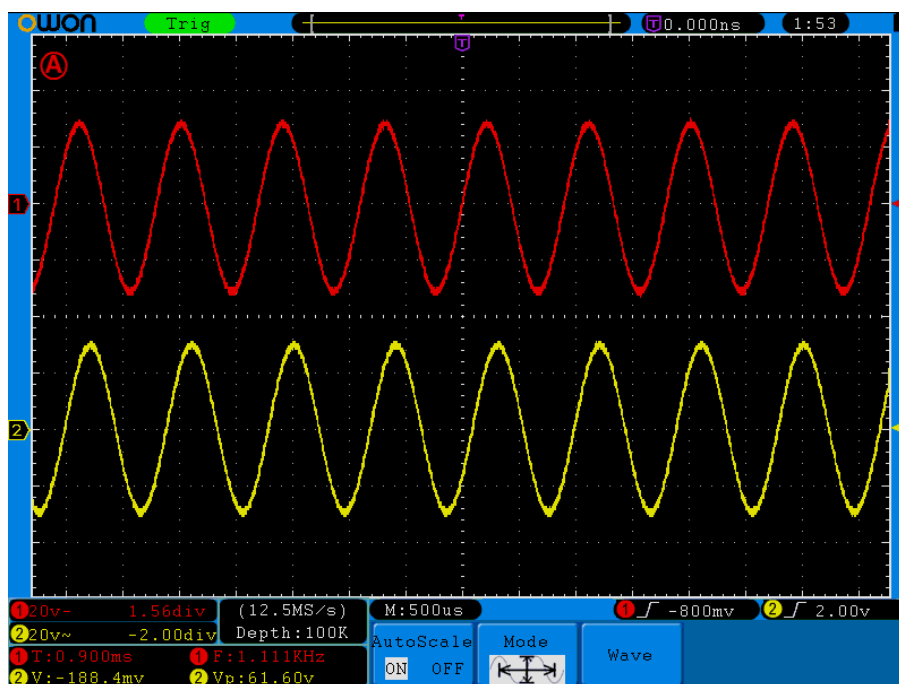

Figure 5-80 Autoscale Horizontal-Vertical multi-period waveforms

**Note:**

1. Entering into Autoscale function and the symbol **Ⓐ** will be flickering on the top left of the screen every 0.5 second.
2. In the mode of Autoscale, the oscilloscope can self-estimate "Trigger Type" (Single, and Alternate) and "Mode" (Edge, Video). At this point, the trigger menu is not available.

3. At the mode of XY and STOP status, pressing **Autoset** to enter into Autoscale, DSO switches to YT mode and AUTO triggering.
4. At the mode of Autoscale, DSO is always set as DC coupling with AUTO triggering. In this case, making Triggering or Coupling settings have no effect.
5. At the mode of Autoscale, if adjust the vertical position, voltage division, trigger level or time scale of CH1 or CH2, the oscilloscope will turn off Autoscale function. To back to Autoscale, press **Autoset**.
6. Turn off the submenu at the Autoscale menu, the Autoscale is off and turn on the submenu still enters into the function.
7. When video triggering, the horizontal time scale is 50us. If one channel is showing edge signal, the other channel is showing video one, the time scale refers to 50us as video one as standard.
8. While the Autoscale is working, settings below will be made forcibly:
  - (1) The DSO will switch from non-main time base to main time base status.
  - (2) The DSO will switch to Peak detection mode if it is in Average mode.

## How to Use Built-in Help

1. Press **Help** button, the catalog will display in the screen.
2. Press **H1** or **H2** to choose help topic, or just turn the **M** knob to choose.
3. Press **H3** to view the details about the topic, or just press the M knob.
4. Press **H5** to exit the help, or just do other operations.

## How to Use Executive Buttons

Executive Buttons include **Autoset**, **Run/Stop**, **Single**, **Copy**.

### Autoset

It's a very useful and quick way to apply a set of pre-set functions to the incoming signal, and display the best possible viewing waveform of the signal and also works out some measurements for user as well.

The details of functions applied to the signal when using **Autoset** are shown as the following table:

Function Items	Setting
Acquisition Mode	Current
Vertical Coupling	DC
Vertical Scale	Adjust to the proper division.
Bandwidth	Full
Horizontal Level	Middle
Horizontal Sale	Adjust to the proper division
Trigger Type	Current
Trigger Source	Show the minimum number of channels.
Trigger Coupling	Current
Trigger Slope	Current
Trigger Level	Mid-point Setting

Trigger Mode	Auto
Display Format	YT

## Judge waveform type by Autoset

Five kinds of types: Sine, Square, video signal, DC level, Unknown signal.

Menu as follow:

Sine: (Multi-period, Single-period, FFT, Cancel Autoset)



Square: (Multi-period, Single-period, Rising Edge, Falling Edge, Cancel Autoset)



Video signal:



DC level, Unknown signal:



### Description for some icons:

- Multi-period: To display multiple periods
- Single-period: To display single period
- FFT: Switch to FFT mode
- Rising Edge: Display the rising edge of square waveform
- Falling Edge: Display the falling edge of square waveform
- Cancel Autoset: Go back to display the upper menu and waveform information

**Run/Stop:** Enable or disable sampling on input signals.

Notice: When there is no sampling at STOP state, the vertical division and the horizontal time base of the waveform still can be adjusted within a certain range, in other words, the signal can be expanded in the horizontal or vertical direction.

When the horizontal time base is  $\leq 50\text{ms}$ , the horizontal time base can be expanded for 4 divisions downwards.

**Single:** Press this button you can set the trigger mode as single directly, so when trigger occurs, acquire one waveform then stop.

**Copy:** You can save the waveform by just pressing the **Copy** panel button in any user interface. The source wave and the storage location are according to the settings of the **Save** function menu when the Type is **Wave**. For more details, please see "Save Function Menu" on P50.



## 6. Communication with PC

Digital storage oscilloscope support communications with a PC through USB, LAN or COM port. You can use the Oscilloscope communication software to store, analyze, display the data and remote control.

Here is how to connect with PC. First, install the Oscilloscope communication software on the supplied CD. Then there are several ways of connection to choose from.

### Using USB Port

- (1) **Connection:** Use a USB data cable to connect the **USB Device port** in the right panel of the Oscilloscope to the USB port of a PC.
- (2) **Install the driver:** Run the Oscilloscope communication software on PC, press F1 to open the help document. Follow the steps of title "**I. Device connection**" in the document to install the driver.
- (3) **Port setting of the software:** Run the Oscilloscope software; click "Communications" in the menu bar, choose "Ports-Settings", in the setting dialog, choose "Connect using" as "USB". After connect successfully, the connection information in the bottom right corner of the software will turn green.

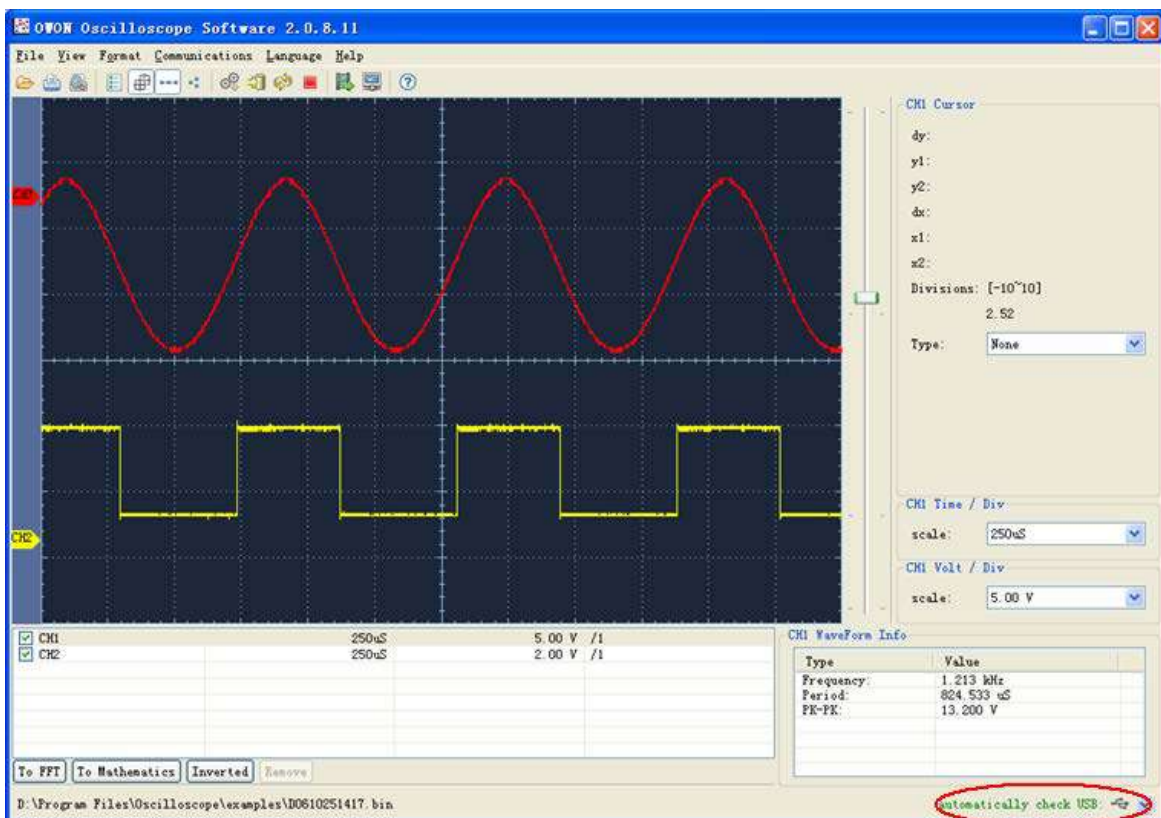

Figure 6-1 Connect with PC through USB port

## Using LAN Port

### Connect directly

- (1) **Connection.** Plug in the LAN line to the LAN port in the right side panel of the oscilloscope; plug the other end into the LAN interface of the computer.
- (2) **Set the network parameters of the computer.** Since the oscilloscope can not support obtaining an IP address automatically, you should assign a static IP address. Here we set the IP address to 192.168.1.71.

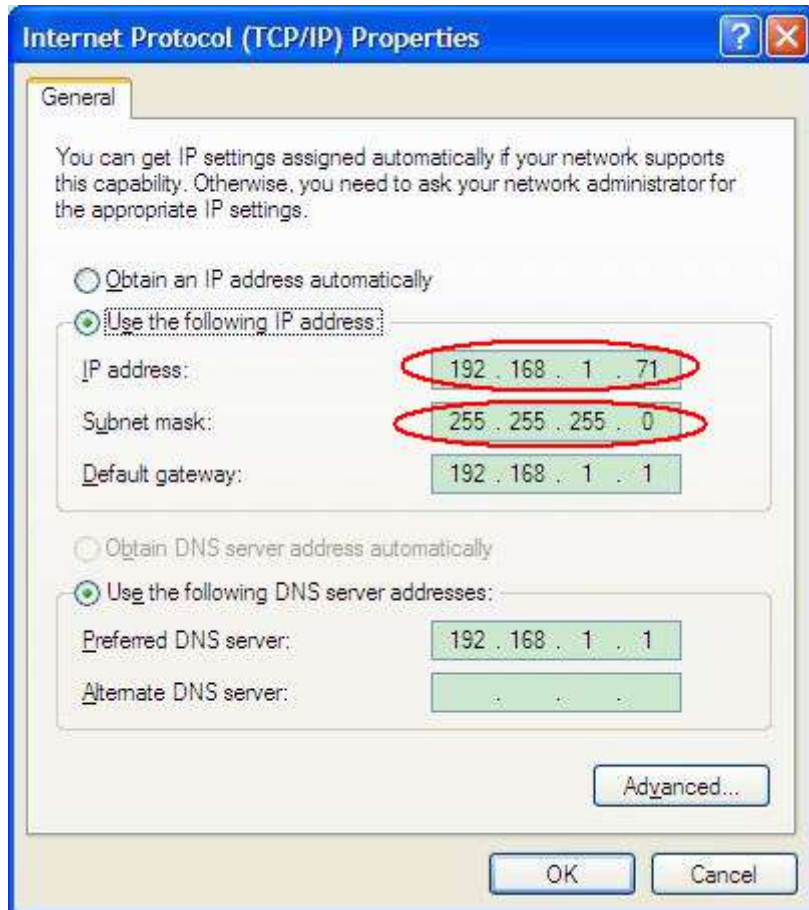

Figure 6-2 Set the network parameters of the computer

- (3) **Set the network parameters of the OWON Oscilloscope Software.** Run the software on the computer; choose the "Ports-settings" of the "Communications" menu item. Set "Connect using" to LAN. About the IP, the first three bytes is same as the IP in the step (2), the last byte should be different. Here, we set it to 192.168.1.72. The range of the port value is 0 - 4000, but the port which under 2000 is always be used, so it is suggested to set it to the value above 2000. Here, we set it to 3000.

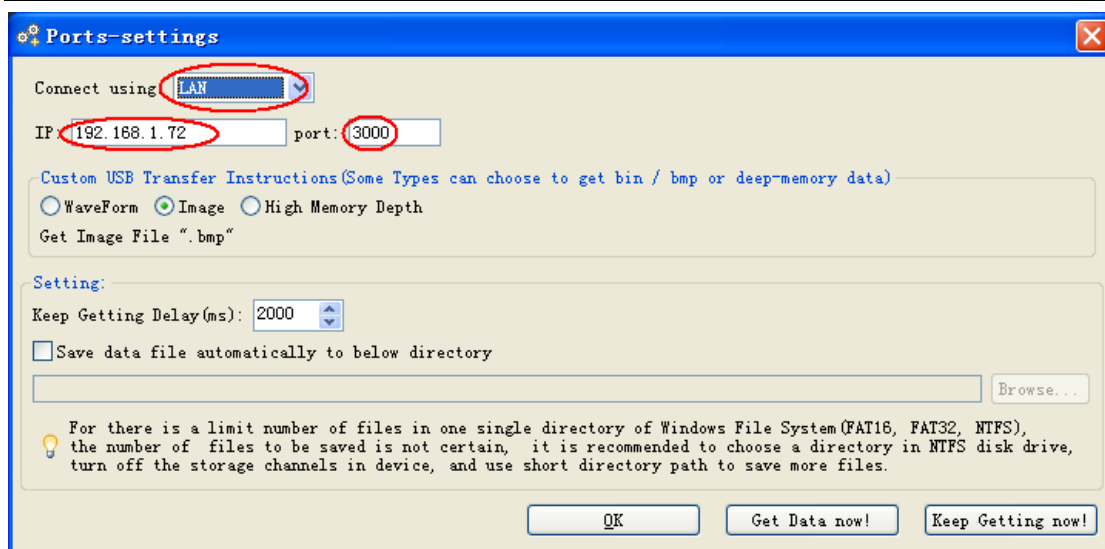

Figure 6-3 Set the network parameters of the OWON Oscilloscope Software

- (4) **Set the network parameters of the oscilloscope.** In the oscilloscope, press the **Utility** button and press **H1** button, turn the **M** knob to select the **LAN Set**; press the **H2** button, the set menu is displayed on the right. Set the **IP** and the **Port** to the same value as the "Ports-settings" in the software in step (3). Press the **H3** button to select "**Save set**", it prompts "reset to update the config". After resetting the oscilloscope, if you can get data normally in the oscilloscope software, the connection is successful.

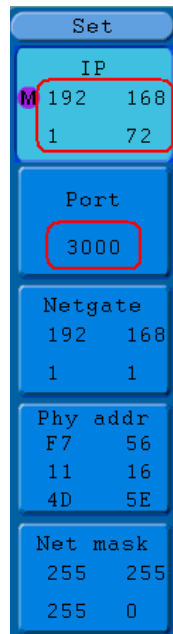

Figure 6-4 Set the network parameters of the oscilloscope

## Connect through a router

- (1) **Connection.** Use a LAN line to connect the oscilloscope with a router, the LAN port of the oscilloscope is in the right side panel; the computer should be connected to the router too.
- (2) **Set the network parameters of the computer.** Since the oscilloscope can not support obtaining an IP address automatically, you should assign a static IP address. The Default gateway and Subnet mask should be set according to the router. Here we

set the IP address to 192.168.1.71, Subnet mask is 255.255.255.0, Default gateway is 192.168.1.1.

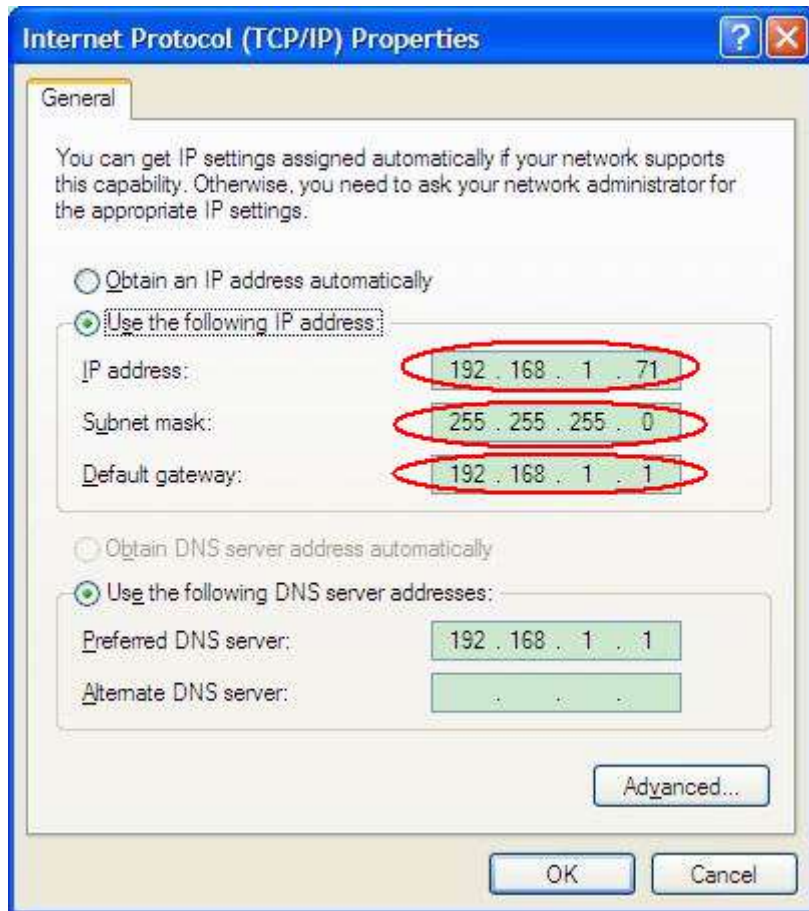

Figure 6-5 Set the network parameters of the computer

- (3) **Set the network parameters of the OWON Oscilloscope Software.** Run the software on the computer; choose the "Ports-settings" of the "Communications" menu item. Set "Connect using" to LAN. About the IP, the first three bytes is same as the IP in the step (2), the last byte should be different. Here, we set it to 192.168.1.72. The range of the port value is 0 - 4000, but the port which under 2000 is always be used, so it is suggested to set it to the value above 2000. Here, we set it to 3000.

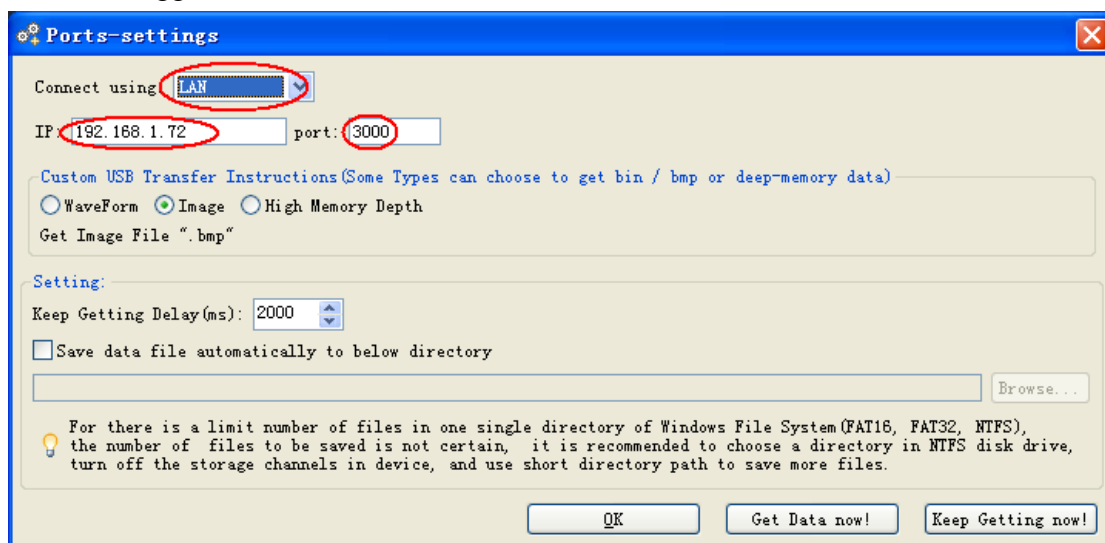

Figure 6-6 Set the network parameters of the OWON Oscilloscope Software

- (4) **Set the network parameters of the oscilloscope.** In the oscilloscope, press the **Utility** button and press **H1** button, turn the **M** knob to select the **LAN Set**; press the **H2** button, the set menu is displayed on the right. Set the **IP** and the **Port** to the same value as the "Ports-settings" in the software in step (3). The Netgate and Net mask should be set according to the router. Press the **H3** button to select "**Save set**", it prompts "reset to update the config". After resetting the oscilloscope, if you can get data normally in the oscilloscope software, the connection is successful.

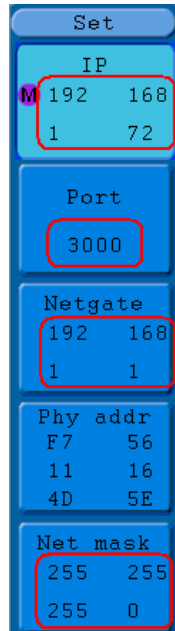

Figure 6-7 Set the network parameters of the oscilloscope

## Using COM Port

- (1) **Connection.** Use a data cable to connect the **COM port** in the right panel of the Oscilloscope, to the COM port of a PC.
- (2) **Port setting of the software:** Run the Oscilloscope software; click "Communications" in the menu bar, choose "Ports-Settings", in the setting dialog, choose "Connect using" as COM.

To learn about how to operate the software, you can press F1 in the software to open the help document.

## 7. Demonstration

### Example 1: Measurement a Simple Signal

The purpose of this example is to display an unknown signal in the circuit, and measure the frequency and peak-to-peak voltage of the signal.

**1. Carry out the following operation steps for the rapid display of this signal:**

- (1) Set the probe menu attenuation coefficient as **10X** and that of the switch in the probe switch as **10X** (see "*How to Set the Probe Attenuation Coefficient*" on P14).
- (2) Connect the probe of **Channel 1** to the measured point of the circuit.
- (3) Press the **Autoset** button.

The oscilloscope will implement the **Autoset** to make the waveform optimized, based on which, you can further regulate the vertical and horizontal divisions till the waveform meets your requirement.

**2. Perform Automatic Measurement**

The oscilloscope can measure most of the displayed signals automatically. To measure the period and frequency of the Channel 1 and the mean and peak-to-peak voltage of the Channel 2, follow below steps:

- (1) Press the **Measure** button to activate the measurement function menu.
- (2) Press the **H1** to display the Add menu.
- (3) Press the **F2** button to choose **CH1** as the source.
- (4) Press the **F1** button, the type items will display at the left of screen, and turn the **M** knob to choose **Period**.
- (5) Press the **F4** button, the period measurement will be added.
- (6) Press the **F1** button again, the type items will display at the left of screen, and turn the **M** knob to choose **Freq**.
- (7) Press the **F4** button, the frequency measurement will be added, finish settings of channel 1.
- (8) Press the **F2** button to choose **CH2** as the source.
- (9) Press the **F1** button, the type items will display at the left of screen, and turn the **M** knob to choose **Mean**.
- (10) Press the **F4** button, the mean measurement will be added.
- (11) Press the **F1** button, the type items will display at the left of screen, and turn the **M** knob to choose **PK-PK**.
- (12) Press the **F4** button, the peak-to-peak voltage measurement will be added, finish

settings of channel 2.

Then, the period, frequency, mean and peak-to-peak voltage will be displayed at the bottom left of the screen and change periodically (see *Figure 7-1*).

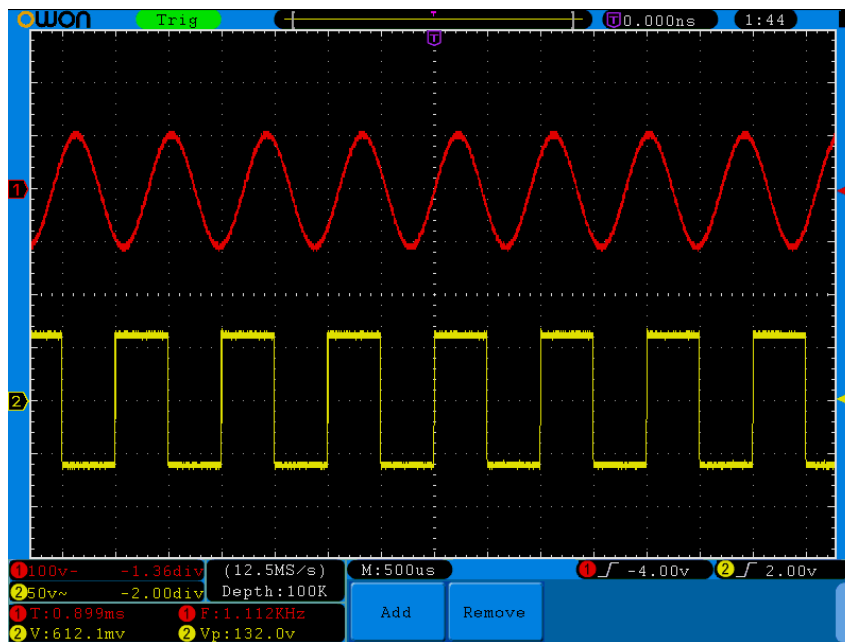

Figure 7-1 Measure Frequency and PK-PK value for a given signal

## Example 2: Gain of a Amplifier in a Metering Circuit

The purpose of this example is to work out the Gain of an Amplifier in a Metering Circuit. First we use Oscilloscope to measure the amplitude of input signal and output signal from the circuit, then to work out the Gain by using given formulas.

Set the probe menu attenuation coefficient as **10X** and that of the switch in the probe as **10X** (see "*How to Set the Probe Attenuation Coefficient*" on P14).

Connect the oscilloscope CH1 channel with the circuit signal input end and the CH2 channel to the output end.

### Operation Steps:

- (1) Press the **Autoset** button and the oscilloscope will automatically adjust the waveforms of the two channels into the proper display state.
- (2) Press the **Measure** button to show the Measure menu.
- (3) Press the **H1** button.
- (4) Press the **F2** button and choose **CH1**.
- (5) Press the **F1** button and turn the **M** knob to choose **PK-PK**.
- (6) Press the **F2** button and choose **CH2**.
- (7) Press the **F1** button again and turn the **M** knob to choose **PK-PK**.
- (8) Read the peak-to-peak voltages of Channel 1 and Channel 2 from the bottom left

of the screen (see *Figure 7-2*).

- (9) Calculate the amplifier gain with the following formulas.

$$\text{Gain} = \text{Output Signal} / \text{Input signal}$$

$$\text{Gain (db)} = 20 \times \log(\text{gain})$$

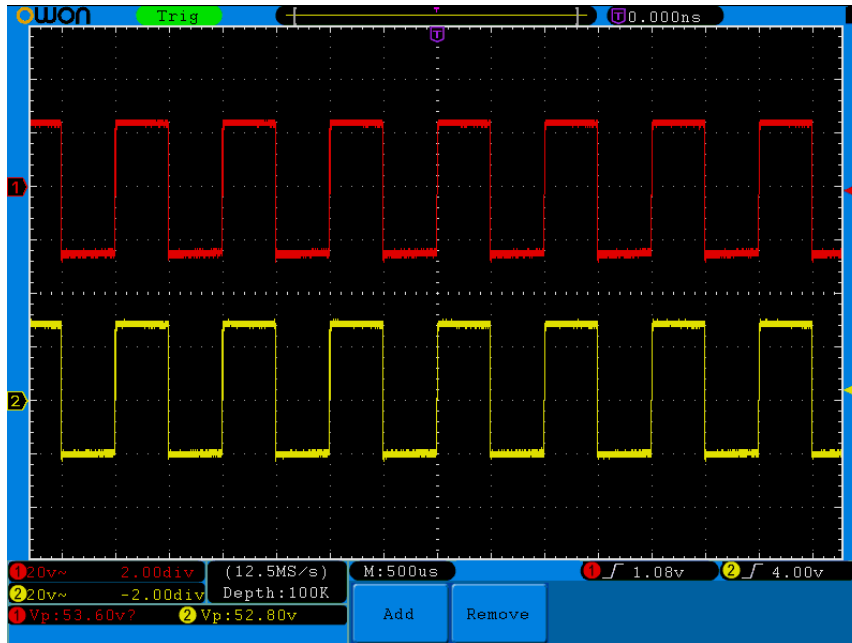

Figure 7-2 Waveform of Gain Measurement

### Example 3: Capturing a Single Signal

It's quite easy to use Digital Oscilloscope to capture non-periodic signal, such as a pulse and burr etc. But the common problem is how to set up a trigger if you have no knowledge of the signal? For example, if the pulse is the logic signal of a TTL level, the trigger level should be set to 2 volts and the trigger edge be set as the rising edge trigger. With various functions supported by our Oscilloscope, user can solve this problem by taking an easy approach. First to run your test using auto trigger to find out the closest trigger level and trigger type, this helps user to make few small adjustments to achieve a proper trigger level and mode. Here is how we achieve this.

**The operation steps are as follows:**

- (1) Set the probe menu attenuation coefficient to 10X and that of the switch in the probe to 10X (see "*How to Set the Probe Attenuation Coefficient*" on P14).
- (2) Adjust the **VOLTS/DIV** and **SEC/DIV** knobs to set up a proper vertical and horizontal ranges for the signal to be observed.
- (3) Press the **Acquire** button to display the Acquire menu.
- (4) Press the **H1** button to display the Acquire Mode menu.
- (5) Press the **F2** button to choose **Peak detect**.



- (6) Press the **Trigger Menu** button to display the Trigger menu.
- (7) Press the **H1** button to display the Trigger Type menu.
- (8) Press the **F1** to choose **Single** as the type.
- (9) Turn the **M** knob to choose **Edge** as the mode.
- (10) Press the **H2** button to display the **Source** menu.
- (11) Press the **F1** button to choose **CH1** as the source.
- (12) Press the **H3** button to display the Coupling menu; press the F2 button to choose **DC** as the Coupling.
- (13) Press the **H4** button to choose  (rising) as the Slope.
- (14) Rotate the **TRIG LEVEL** knob and adjust the trigger level to the roughly 50% of the signal to be measured.
- (15) Check the Trigger State Indicator on the top of the screen, if it is not Ready, push down the **Run/Stop** button and start acquiring, wait for trigger to happen. If a signal reaches to the set trigger level, one sampling will be made and then displayed in the screen. By using this approach, a random pulse can be captured easily. For instance, if we want to find a burst burr of high amplitude, set the trigger level to a slightly higher value of the average signal level, press the **Run/Stop** button and wait a trigger. Once there is a burr occurring, the instrument will trigger automatically and record the waveform during the period around the trigger time. By turning the **HORIZONTAL POSITION** knob in the horizontal control area in the panel, you can change the horizontal triggering position to obtain the negative delay, making an easy observation of the waveform before the burr occurs (see *Figure 7-3*).

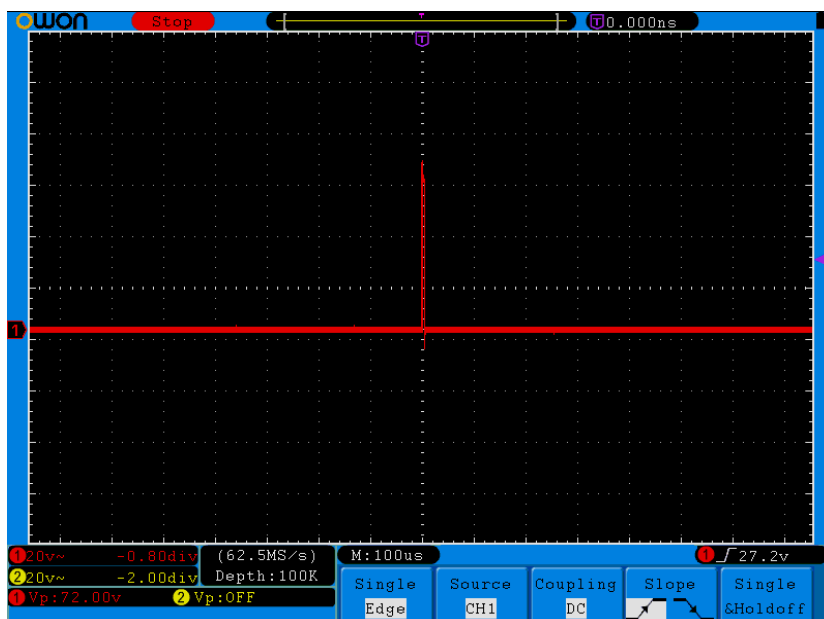

Figure 7-3 Capturing a Single Signal

## Example 4: Analyze the Details of a Signal

Noise is very common inside most of the electronic signal. To find out what's inside the noise and reduce the level of noise is very important function our oscilloscope is capable to offer.

### Noise Analysis

The level of noise sometime indicates a failure of electronic circuit. The Peak Detect functions acts an important role to help you to find out the details of these noise. Here is how we do it:

- (1) Press the **Acquire** button to display the Acquire menu.
- (2) Press the **H1** button to display **ACQU Mode** menu.
- (3) Press the **F2** button to choose **Peak detect**.

The signal displayed on the screen containing some noise, by turning on Peak Detect function and changing time base to slow down the incoming signal, any peaks or burr would be detected by the function (see *Figure 7-4*).

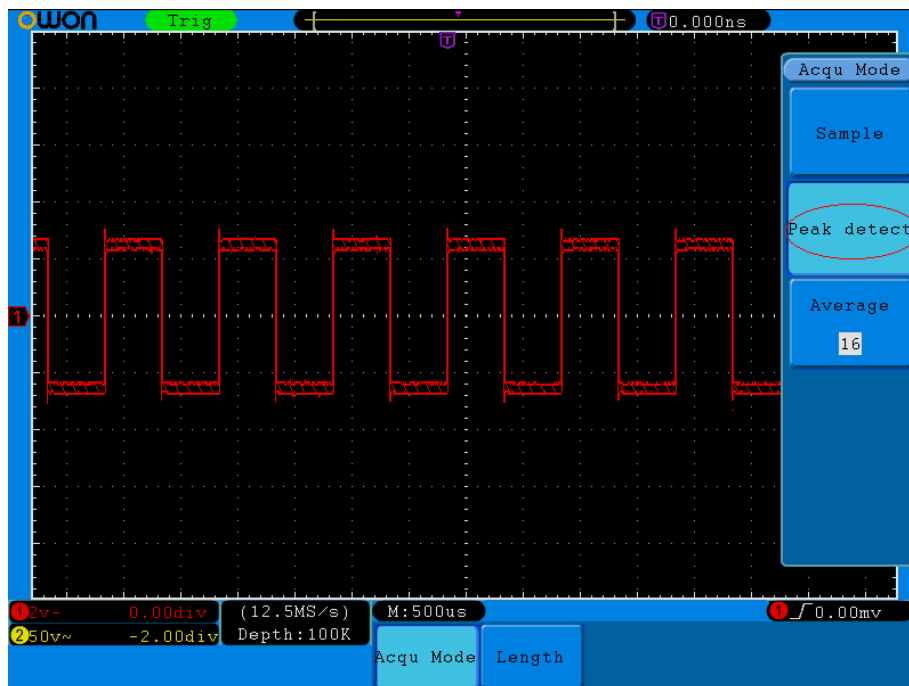

Figure 7-4 Signal with Noises

### Separate Noises from the Signal

When focusing on signal itself, the important thing is to reduce the noise level as lower as possible, this would enable user to have more details about the signal. The Average function offered by our Oscilloscope can help you to achieve this.

Here are the steps for how to enable Average function.

- (1) Press the **Acquire** button to display the Acquire menu.

- (2) Press the **H1** button to display **ACQU Mode** menu.
- (3) Press the **F3** button, turn the **M** knob and observe the waveform obtained from averaging the waveforms of different average number.

User would see a much reduced random noise level and make it easy to see more details of the signal itself. After applying Average, user can easily identify the burrs on the rising and falling edges of some part of the signal (see *Figure 7-5*).

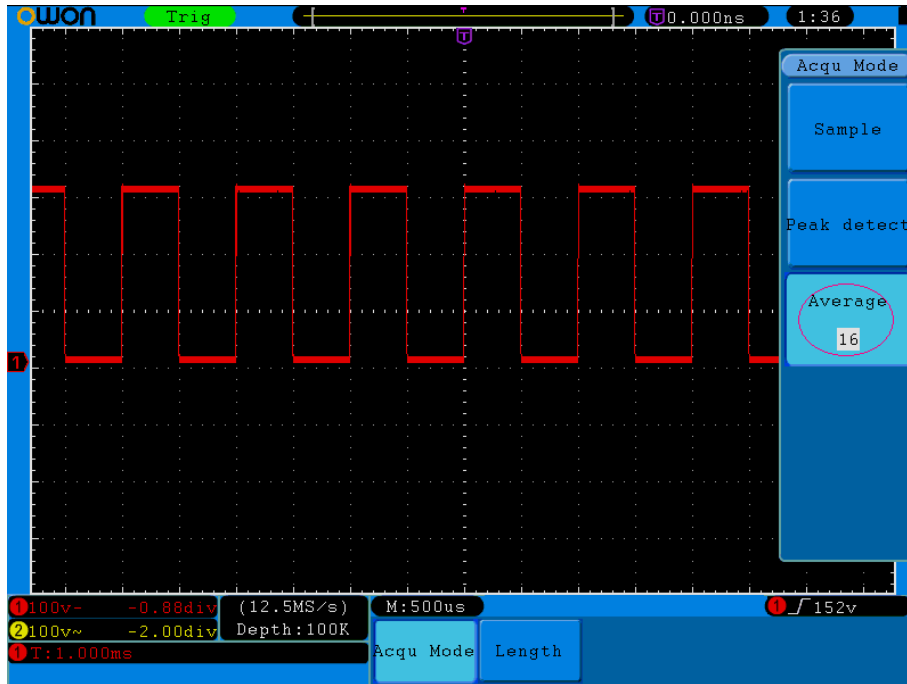

Figure 7-5 Reduce Noise level by using Average function

## Example 5: Application of X-Y Function

### Examine the Phase Difference between Signals of two Channels

Example: Test the phase change of the signal after it passes through a circuit network.

X-Y mode is a very useful when examining the Phase shift of two related signals. This example takes you step by step to check out the phase change of the signal after it passes a specified circuit. Input signal to the circuit and output signal from circuit are used as source signals.

For the examination of the input and output of the circuit in the form of X-Y coordinate graph, please operate according to the following steps:

- (1) Set the probe menu attenuation coefficient for **10X** and that of the switch in the probe for **10X** (see "*How to Set the Probe Attenuation Coefficient*" on P14).
- (2) Connect the probe of channel 1 to the input of the network and that of Channel 2 to the output of the network.
- (3) Push down the **Autoset** button, with the oscilloscope turning on the signals of the two channels and displaying them in the screen.

- (4) Turn the **VOLTS/DIV** knob, making the amplitudes of two signals equal in the rough.
- (5) Press the **Display** button and recall the Display menu.
- (6) Press the **H3** button and choose **XY Mode** as **ON**.  
The oscilloscope will display the input and terminal characteristics of the network in the Lissajous graph form.
- (7) Turn the **VOLTS/DIV** and **VERTICAL POSITION** knobs, optimizing the waveform.
- (8) With the elliptical oscillogram method adopted, observe and calculate the phase difference (see *Figure 7-6*).

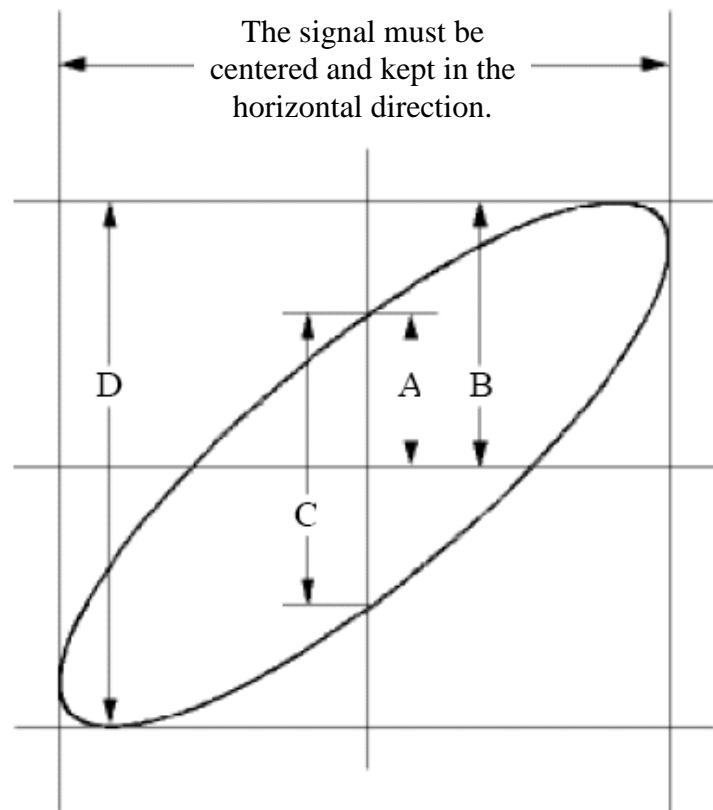

Figure 7-6 Lissajous Graph

Based on the expression  $\sin(\mathbf{q}) = \mathbf{A/B}$  or  $\mathbf{C/D}$ , thereinto,  $\mathbf{q}$  is the phase difference angle, and the definitions of A, B, C, and D are shown as the graph above. As a result, the phase difference angle can be obtained, namely,  $\mathbf{q} = \pm \arcsin(\mathbf{A/B})$  or  $\pm \arcsin(\mathbf{C/D})$ . If the principal axis of the ellipse is in the I and III quadrants, the determined phase difference angle should be in the I and IV quadrants, that is, in the range of  $(0 - \pi/2)$  or  $(3\pi/2 - 2\pi)$ . If the principal axis of the ellipse is in the II and IV quadrants, the determined phase difference angle is in the II and III quadrants, that is, within the range of  $(\pi/2 - \pi)$  or  $(\pi - 3\pi/2)$ .

## Example 6: Video Signal Trigger

Observe the video circuit of a television, apply the video trigger and obtain the stable video output signal display.

### Video Field Trigger

For the trigger in the video field, carry out operations according to the following steps:

- (1) Press the **Trigger Menu** button to display the trigger menu.
- (2) Press the **H1** button to display the trigger type menu.
- (3) Press the **F1** button to choose **Single** for Type.
- (4) Turn the **M** knob to choose **Video** as the mode.
- (5) Press the **H2** button to display the Source menu.
- (6) Press the **F1** button to choose **CH1** for Source.
- (7) Press the **H3** button to display the Modu menu.
- (8) Press the **F1** button to choose **NTSC** for the modulation.
- (9) Press the **H4** button to display the sync menu.
- (10) Press the **F2** button to choose **Field** for Sync.
- (11) Turn the **VOLTS/DIV**, **VERTICAL POSITION** and **SEC/DIV** knobs to obtain a proper waveform display (see *Figure 7-7*).

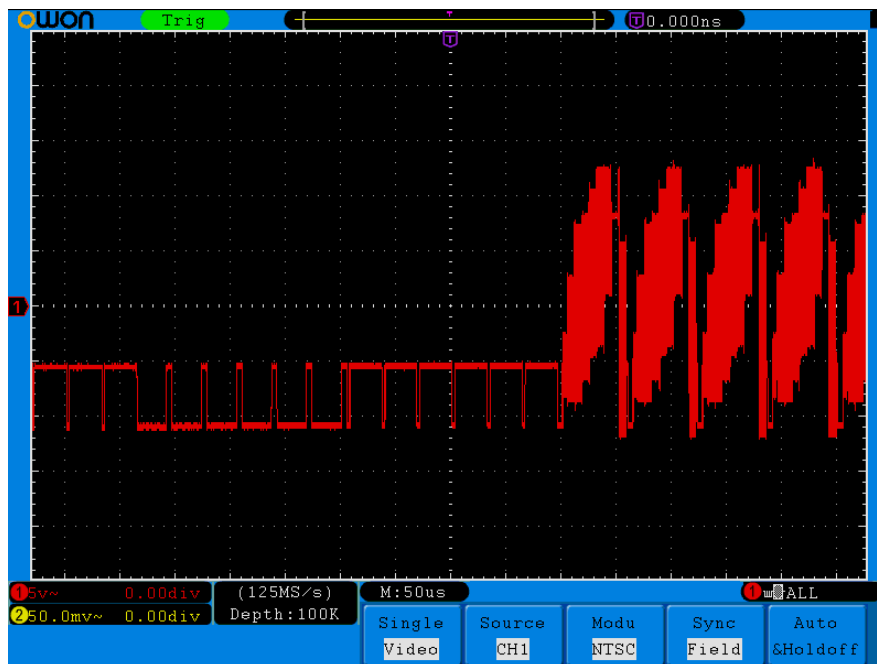

Figure 7-7 Waveform Captured from Video Field Trigger

## 8. Troubleshooting

### 1. Oscilloscope is powered on but no Display.

- Check whether the power connection is connected properly.
- Check whether the power switch is pushed down to the designated position.
- Check whether the fuse which is beside the AC power input jack is blew (the cover can be pried open with a straight screwdriver).
- Restart the instrument after completing the checks above.
- If the problem persists, please contact OWON and we will be under your service.

### 2. After acquiring the signal, the waveform of the signal is not displayed in the screen.

- Check whether the probe is properly connected to the signal connecting wire.
- Check whether the signal connecting wire is correctly connected to the BNC (namely, the channel connector).
- Check whether the probe is properly connected with the object to be measured.
- Check whether there is any signal generated from the object to be measured (the trouble can be shot by the connection of the channel from which there is a signal generated with the channel in fault).
- Make the signal acquisition operation again.

### 3. The measured voltage amplitude value is 10 times or 1/10 of the actual value.

Look at the attenuation coefficient for the input channel and the attenuation ration of the probe, to make sure they are match (see "*How to Set the Probe Attenuation Coefficient*" on P14).

### 4. There is a waveform displayed, but it is not stable.

- Check whether the **Source** item in the **TRIG MODE** menu is in conformity with the signal channel used in the practical application.
- Check on the trigger **Type** item: The common signal chooses the **Edge** trigger mode for **Type** and the video signal the **Video**. If Alternate trigger is selected, both of the channel 1 and channel 2 trigger levels should be adjusted to the proper position. Only if a proper trigger mode is applied, the waveform can be displayed steadily.
- Try to change the trigger coupling into the high frequency suppress and the low frequency suppress to smooth the high frequency or low frequency noise triggered by the interference.

### 5. No Display Responses to the Push-down of Run/Stop.

Check whether Normal or Signal is chosen for Polarity in the TRIG MODE menu and the trigger level exceeds the waveform range.

If it is, make the trigger level is centered in the screen or set the trigger mode as Auto. In addition, with the **Autoset** button pressed, the setting above can be completed automatically.

### 6. The displaying of waveform seems getting slow after increasing AVERAGE value in Acqu Mode (see "*How to Implement Sampling Setup*" on P44 ), or a longer duration is set in the Persist in Display (see "*Persist*" on P47).

It's normal as the Oscilloscope is working hard on many more data points.

## 9. Technical Specifications

Unless otherwise specified, the technical specifications applied are for SDS series only, and Probes attenuation set as 10X. Only if the oscilloscope fulfills the following two conditions at first, these specification standards can be reached.

- This instrument should run for at least 30 minutes continuously under the specified operating temperature.
- If change of the operating temperature is up to or exceeds 5°C, do a "Self-calibration" procedure (see "*How to Implement Self-calibration*" on P15).

All specification standards can be fulfilled, except one(s) marked with the word "Typical".

Performance Characteristics		Instruction		
<b>Bandwidth</b>		SDS6062(V)	60 MHz	
		SDS7072(V)	70 MHz	
		SDS7102(V)	100 MHz	
		SDS7202(V)	200 MHz	
		SDS8102(V)	100 MHz	
		SDS8202(V)	200 MHz	
		SDS8302	300 MHz	
		SDS9302	300 MHz	
<b>Channel</b>		2 + 1 (External)		
<b>Acquisition</b>	Mode	Normal, Peak detect, Averaging		
	Sample rate (real time)	SDS6062(V)	Dual CH	250 MS/s
			Single CH	500 MS/s
		SDS7072(V)	Dual CH	500 MS/s
			Single CH	1 GS/s
		SDS7102(V)	Dual CH	500 MS/s
			SDS7202(V)	Single CH
		SDS8102(V)	Dual CH	1 GS/s
			Single CH	2 GS/s
		SDS8202(V)	Dual CH	1 GS/s
			Single CH	2 GS/s
		SDS8302	Dual CH	1.25 GS/s
			Single CH	2.5 GS/s
		SDS9302	Dual CH	1.6 GS/s
Single CH			3.2 GS/s	
<b>Input</b>	Input coupling	DC, AC, Ground		
	Input impedance	1 MΩ ± 2%, in parallel with 15 pF±5 pF (Note: 10 pF±5 pF for SDS6062(V))		
	Probe attenuation factor	1X, 10X, 100X, 1000X		

9. Technical Specifications

Performance Characteristics		Instruction				
	Max. input voltage	400 V (DC + AC Peak)				
	Bandwidth limit	20 MHz, full bandwidth (not including SDS6062(V) )				
	Channel –channel isolation	50 Hz: 100 : 1 10 MHz: 40 : 1				
	Time delay between channel(typical)	150ps				
<b>Horizontal System</b>	Sampling rate range	SDS6062(V)	Dual CH	0.5S/s - 250MS/s		
			Single CH	0.5S/s - 500MS/s		
		SDS7072(V)	Dual CH	0.5S/s - 500MS/s		
			Single CH	0.5S/s - 1GS/s		
		SDS7102(V) SDS7202(V)	Dual CH	0.5S/s - 500MS/s		
			Single CH	0.5S/s - 1GS/s		
		SDS8102(V)	Dual CH	0.5S/s - 1GS/s		
			Single CH	0.5S/s - 2GS/s		
		SDS8202(V)	Dual CH	0.5S/s - 1GS/s		
			Single CH	0.5S/s - 2GS/s		
		SDS8302	Dual CH	0.5S/s - 1.25GS/s		
			Single CH	0.5S/s - 2.5GS/s		
		SDS9302	Dual CH	0.5S/s - 1.6GS/s		
			Single CH	0.5S/s - 3.2GS/s		
		Interpolation	(sin x)/x			
		Max Record length	SDS6062(V)	Dual CH	≤Max sampling rate	10M
	Single CH			≤Max sampling rate	10M	
	SDS7072(V)		Dual CH	≤Max sampling rate	10M	
			Single CH	≤Max sampling rate	10M	
	SDS7102(V) SDS7202(V)		Dual CH	≤Max sampling rate	10M	
Single CH			≤Max sampling rate	10M		
SDS8102(V)	Dual CH		≤500 MS/s	10M		
			1 GS/s	10K		
	Single CH		≤1 GS/s	10M		
			2 GS/s	10K		
SDS8202(V)	Dual CH		≤500 MS/s	10M		
			1 GS/s	10K		
	Single CH		≤1 GS/s	10M		
			2 GS/s	10K		



9. Technical Specifications

Performance Characteristics		Instruction			
		SDS8302	Dual CH	≤500 MS/s	10M
				1 GS/s	10K
			1.25 GS/s		
			Single CH	≤1 GS/s	10M
		2 GS/s		10K	
		2.5 GS/s			
		SDS9302	Dual CH	≤400 MS/s	10M
				800 MS/s	10K
	1.6 GS/s				
	Single CH		≤800 MS/s	10M	
		1.6 GS/s	10K		
	3.2 GS/s				
Scanning speed (S/div)	SDS6062(V)	5 ns/div – 100 s/div, step by 1 - 2 - 5			
	SDS7072(V)	2 ns/div – 100 s/div, step by 1 - 2 - 5			
	SDS7102(V) SDS7202(V)	2 ns/div – 100 s/div, step by 1 - 2 - 5			
	SDS8102(V)	1 ns/div – 100 s/div, step by 1 - 2 - 5			
	SDS8202(V)	1 ns/div – 100 s/div, step by 1 - 2 - 5			
	SDS8302	1 ns/div – 100 s/div, step by 1 - 2 - 5			
	SDS9302	1 ns/div – 100 s/div, step by 1 - 2 - 5			
Sampling rate / relay time accuracy	±100 ppm				
Interval(ΔT) accuracy (DC - 100MHz)	Single: ±(1 interval time+100 ppm×reading+0.6 ns); Average>16: ±(1 interval time +100 ppm×reading+0.4 ns)				
Vertical system	A/D converter	8 bits resolution (2 Channels simultaneously)			
	Sensitivity	2 mV/div – 10 V/div			
	Displacement	SDS6062(V) SDS7072(V)	± 10 div		

## 9. Technical Specifications

Performance Characteristics		Instruction		
		SDS7102(V) SDS7202(V) SDS8102(V) SDS8202(V) SDS8302 SDS9302	±1 V (2 mV/div – 100 mV/div) ±10 V (200 mV/div – 1 V/div) ±100 V (2 V/div – 10 V/div)	
	Analog bandwidth	60 MHz, 100 MHz, 200 MHz, 300 MHz		
	Single bandwidth	Full bandwidth		
	Low Frequency	≥10 Hz (at input, AC coupling, -3 dB)		
	Rise time	SDS6062(V)	≤ 5.8 ns (at input, Typical)	
		SDS7072(V)	≤ 5.0 ns (at input, Typical)	
		SDS7102(V)	≤ 3.5 ns (at input, Typical)	
		SDS7202(V)	≤ 1.7 ns (at input, Typical)	
		SDS8102(V)	≤ 3.5 ns (at input, Typical)	
		SDS8202(V)	≤ 1.7 ns (at input, Typical)	
		SDS8302	≤ 1.17 ns (at input, Typical)	
		SDS9302	≤ 1.17 ns (at input, Typical)	
	DC gain accuracy	±3%		
	DC accuracy (average)	Average > 16: ±(3% rdg + 0.05 div) for ΔV		
	Waveform inverted ON/OFF			
Measurement	Cursor	ΔV and ΔT between cursors		
	Automatic	Period, Freq, Mean, PK-PK, RMS, Max, Min, Vtop, Vbase, Vamp, OverShoot, PreShoot, Rise Time, Fall Time, +D width, -D width, +Duty, -Duty, Delay A→B $\overleftrightarrow{\Psi}$ , Delay A→B $\overleftarrow{\Psi}$ , Cycle RMS, Cursor RMS, Duty cycle, and Phase.		
	Waveform Math	+, -, *, / ,FFT		
	Waveform storage	15 waveforms		
	Lissajous figure	Bandwidth	Full bandwidth	
		Phase difference	±3 degrees	
	Frequency ( typical)	1 KHz square wave		

## 9. Technical Specifications

Performance Characteristics	Instruction
<b>Communication port</b>	USB 2.0, USB for file storage; LAN port; VGA interface (only for the model with "V" or the models including VGA interface as default) or RS-232 (Optional);

### Trigger:

Performance Characteristics	Instruction
Trigger level range	Internal $\pm 6$ div from the screen center
	EXT $\pm 600$ mV
	EXT/5 $\pm 3$ V
Trigger level Accuracy (typical)	Internal $\pm 0.3$ div
	EXT $\pm (40 \text{ mV} + 6\% \text{ of Set Value})$
	EXT/5 $\pm (200 \text{ mV} + 6\% \text{ of Set Value})$
Trigger displacement	According to Record length and time base
Trigger Holdoff range	100 ns – 10 s
50% level setting (typical)	Input signal frequency $\geq 50$ Hz
Edge trigger	slope Rising, Falling
	Sensitivity 0.3 div
Pulse trigger	Trigger condition Positive pulse: $>$ , $<$ , $=$ negative pulse: $>$ , $<$ , $=$
	Pulse Width range 30 ns – 10 s
Video Trigger	Modulation Support standard NTSC, PAL and SECAM broadcast systems
	Line number range 1-525 (NTSC) and 1-625 (PAL/SECAM)
Slope Trigger	Trigger condition Positive pulse: $>$ , $<$ , $=$ negative pulse: $>$ , $<$ , $=$
	Time setting 24 ns – 10 s
Alternate Trigger	Trigger on CH1 Edge, Pulse, Video, Slope
	Trigger on CH2 Edge, Pulse, Video, Slope

## General Technical Specifications

### Display

Display Type	8" Colored LCD (Liquid Crystal Display)
Display Resolution	800 (Horizontal) × 600 (Vertical) Pixels
Display Colors	65536 colors, TFT screen

### Output of the Probe Compensator

Output Voltage (Typical )	About 5 V, with the Peak-to-Peak voltage $\geq 1 \text{ M}\Omega$ .
Frequency (Typical )	Square wave of 1 KHz

### Power

Mains Voltage	100 - 240 VAC RMS, 50/60 Hz, CAT II
Power Consumption	< 18 W---SDS6062(V) < 24 W---Other models
Fuse	2 A, T grade, 250 V
Battery (optional)	Cell:558792 4000 mAh/3.7 V Pack:2s2p 7.4 V/8000 mAh

### Environment

Temperature	Working temperature: 0 °C - 40 °C Storage temperature: -20 °C - 60 °C
Relative Humidity	$\leq 90\%$
Height	Operating: 3,000 m Non-operating: 15,000 m
Cooling Method	Natural convection

### Mechanical Specifications

Dimension	340 mm× 155 mm×70 mm (L*H*W)
Weight	About 1.82 kg

### Interval Period of Adjustment:

One year is recommended for the calibration interval period.

# 10. Appendix

## Appendix A: Enclosure

### Standard Accessories:

- A pair of Passive probe: 1.2 m, 1:1 (10:1)
- 1x CD (PC link application software)
- 1x Power cord: up to the standards of the country in which it is used.
- 1x USB cable
- 1x Quick Guide

### Options:

- Battery

## Appendix B: General Care and Cleaning

### General Care

Do not store or leave the instrument where the liquid crystal display will be exposed to direct sunlight for long periods of time.

**Caution:** To avoid any damage to the instrument or probe, do not exposed it to any sprays, liquids, or solvents.

### Cleaning

Inspect the instrument and probes as often as operating conditions require.

To clean the instrument exterior, perform the following steps:

1. Wipe the dust from the instrument and probe surface with a soft cloth. Do not make any scuffing on the transparent LCD protection screen when clean the LCD screen.
2. Disconnect power before cleaning your Oscilloscope. Clean the instrument with a wet soft cloth not dripping water. It is recommended to scrub with soft detergent or fresh water. To avoid damage to the instrument or probe, do not use any corrosive chemical cleaning agent.



**Warning:** Before power on again for operation, it is required to confirm that the instrument has already been dried completely, avoiding any electrical short circuit or bodily injury resulting from the moisture.

---

## Appendix C: Battery Using Guide

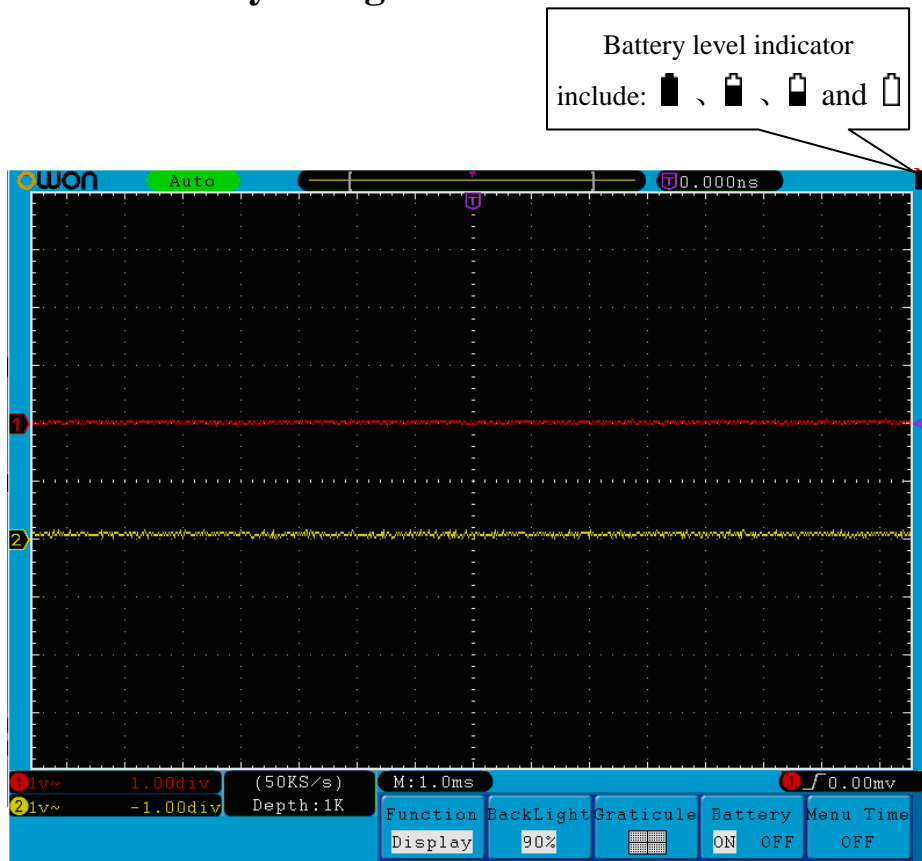







Figure 10-1 Battery level indicator

### Charging the oscilloscope

Connect the power cord to a power source. Turn on the Power Switch Button  on the left side (make sure the "—" side is pressed down). Yellow light of the indicator on the front panel means the battery is being charged. Once the battery is full, the indicator will become green.

The lithium battery may not be fully charged when you receive it. Please charge the battery for 12 hours before the first use. Your battery can last 4 hours depending on your usage after fully charged.

There will have battery power indication show on the top of panel when oscilloscope power supplied by the battery (if no indication has appeared, see "Display" on P66).

, ,  and  indicates the level of your battery. When  shows it means the power can only supply for 5 minutes maximum.

### Note:

To avoid overheat of battery during charging, the ambient temperature is not allowed to exceed the permissible value given in technical specification.

### Replacing the Lithium Battery Unit

It is usually not required to replace the battery unit. But when it is required to replace it, only qualified personnel can carry out this operation, and only use the same specification lithium battery.