

# TENMARS

## Lux Light Meter

### TM-215

#### User's Manual

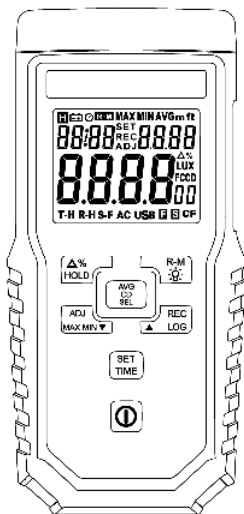

HB2TM2150001



# CONTENTS

1	Introduction .....	1
2	Accessories.....	1
3	Safety Precaution.....	1
4	Meter Description.....	2
5	Operation .....	3
5.1	Power Button.....	3
5.2	Turn on backlight (Backlight).....	3
5.3	Data hold (HOLD) .....	3
5.4	Time display (Time).....	3
5.5	Luminous intensity display (CD) .....	4
5.6	Auto zero (ADJ 0).....	4
5.7	Manual Record.....	5
5.8	Manual Record Reading.....	5
5.9	Auto-recording (Data Logger).....	6
5.10	Disable Auto Power Off .....	7
5.11	Transmittance $\Delta\%$ .....	7
5.12	Averaging 4 or 5 points .....	8
5.13	Maximum and Minimum Hold .....	11
5.14	Function Settings (Setup).....	11
6	Software Installation .....	18
7	General Specifications .....	19
8	Electrical Specifications:.....	20
8.1	Quality Indices.....	20
8.2	Relative Visible Spectrum Response.....	21
9	Maintenance or Repair .....	22
10	PRECAUTIONS .....	22
11	AC to DC Adaptor .....	23
12	Replace the battery .....	23
13	End of Life Disposal .....	24



## 1 Introduction

Lux Light Meter is designed for measuring Luminance (unit: Lux/FC) and Luminous intensity (unit: candela or CD), while complying with the specifications: DIN5032-7-2017 Class C, JJG 245-2005 Class B, JIS C 1609-1: 2006 Class A, CNS5119.

## 2 Accessories

- 1 Meter
- 1 User manual
- 1 USB cable
- 1 9V battery
- 1 Carrying case
- 1 AC 100~240V to DC 9V/0.5A(9mm) adaptor

## 3 Safety Precaution

	Note! Please refer to this manual. Improper use may damage the meter and its components.
	Complies with European Directive.

- Do not operate in environments with flammable gas or humid environments.
- Operating altitude: up to 2000M.
- Operating environment: Indoor use; Pollution degree 2.
- Clean with soft cloth when dirty, such as glasses cloth. Do not clean with chemicals and other solvents.
- ◇ **Class B** – Equipment for use in all establishments other than domestic.
- ◇ **Group 1** – RF energy generated is needed for internal functioning.

## 4 Meter Description

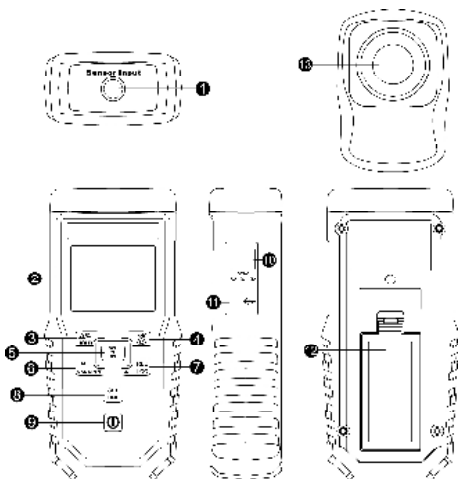

- |    |  |     |                 |
|----|--|-----|-----------------|
| 1. | Probe jack   | 9.  | Power button    |
| 2. | Display  | 10. | DC power jack   |
| 3. | Data hold button /<br>Transmittance button                     | 11. | USB port        |
| 4. | Backlight button   | 12. | Battery cover   |
| 5. | Candela (CD) button /<br>Average button (for 4 or<br>5 points) | 13. | Light-detecting |
| 6. | Zero button / Maximum<br>and minimum button                    |     |                 |
| 7. | Manual record (REC)/<br>Auto record (LOG)                      |     |                 |
| 8. | Time display button /<br>Set button                            |     |                 |

## 5 Operation

### 5.1 Power Button



Press  button to turn on or turn off the power.

### 5.2 Turn on backlight (Backlight)

Press  button to turn on or turn off the backlight.

- ◇ The backlight will be turned off automatically after lighting up for 15 seconds.
- ◇ The backlight will be turned on automatically when the meter is connected to USB or AC POWER.

### 5.3 Data hold (HOLD)

Press  button to hold the displayed value, then a symbol  will appear. Press again to disable it and the symbol  disappears.

- ◇ When the reading is held, you can only turn off the power and use the backlight switch.

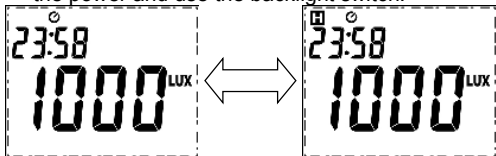

### 5.4 Time display (Time)

Change the display mode of hour-minute, second, date or year.



Press  button to change the display mode. If rebooting, the display mode will be set to "hour: minute".

### 5.5 Luminous intensity display (CD)

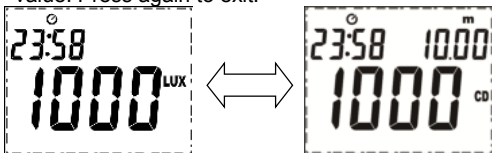
Press  button to convert as Luminous intensity mode (CD). The digit shown on the upper right corner of the display represents the distance setting value. Press again to exit.



### 5.6 Auto zero (ADJ 0)

Press  button to zeroing and the symbol **[CAL]** will appear. If the meter is not covered with a cap during ADJ or not covered with a cap when  button pressed, the symbol **[CAP]** will appear.

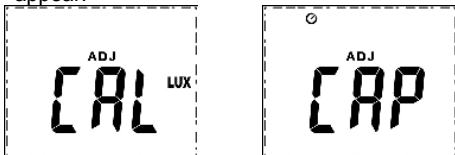

### 5.7 Manual Record



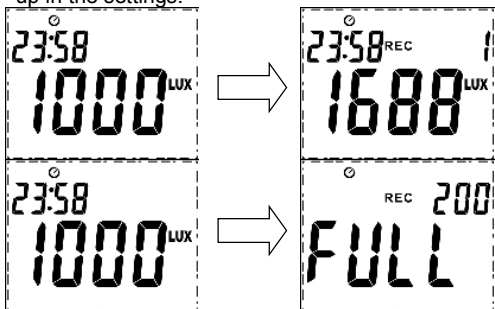

With the function, the present value displayed can be recorded manually, including time, the luminance value, and the distance for luminous intensity.

With pressing  button, the current recorded number and the symbol REC display. The logs of manual record are up to 200. If more than 200 logs, the symbol FULL displays, the logs can be cleared up in the settings.



### 5.8 Manual Record Reading

This function can read 200 records of manual data, including time, illuminance value, candle value and candle distance setting.

Press  more than 2 seconds, and **R-M** appears on the LCD. Press  or  to select the log number for reading. Press  more than 2 seconds to quit this mode.



## TENMARS



## TM-215



### 5.9 Auto-recording (Data Logger)

This function is designed to record the present luminance value, time, and the maximum log number is 7000.

Press  button for 2 seconds to enable or disable the auto-record function. The symbol LOG and REC display as display turned on, and the interval is 1 minutes in the initial setting. The symbol REC will flash when recording.

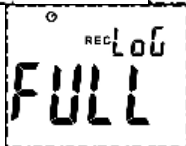

- ✧ Connect the meter to a computer for the settings of auto-recording and data-reading.
- ✧ The function auto-power off will be disabled when automatic recording enabled.
- ✧ When the log number is up to 7000, the symbol **FULL** appears until exiting the auto-recording mode or power off.

### 5.10 Disable Auto Power Off

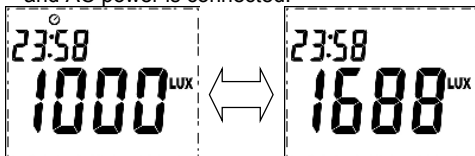

Press and hold  button for 2 seconds to disable or reset to the auto-power-off when power on.

- ✧ The time for auto-power off is 15 minutes.
- ✧ Auto-power off function will be disabled after USB and AC power is connected.



### 5.11 Transmittance $\Delta\%$

This function is designed for the measurement of light transmittance.

Press  button for 2 seconds to enter or exit the menu for transmittance. Entering the menu and the reference value is shown, press  button for 1 second to confirm the present reference value, and enter the mode of transmittance percentage. At this moment, press  button for 2 seconds to confirm the present reference value.

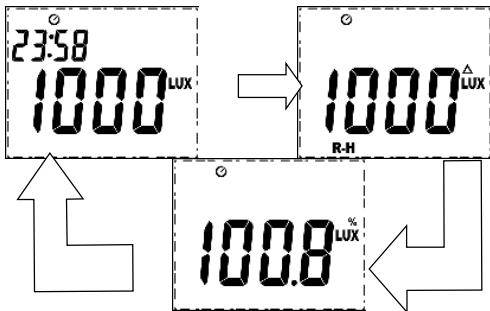



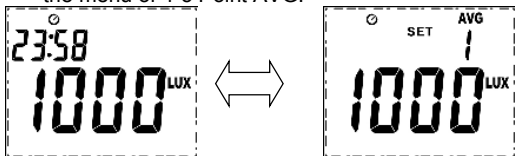

### 5.12 Averaging 4 or 5 points

This function is designed to calculate the average value with four or five measuring points as the average of the luminance measurement for the environment.

1. Press  button for 2 seconds to enter or exit the menu of 4-5 Point AVG.



2. Press  button or  button to select points 1, 2, 3, 4, and C.
3. With  button pressed, the luminance measuring starts; with  button pressed again, the measuring data are recorded.

# TENMARS

# TM-215

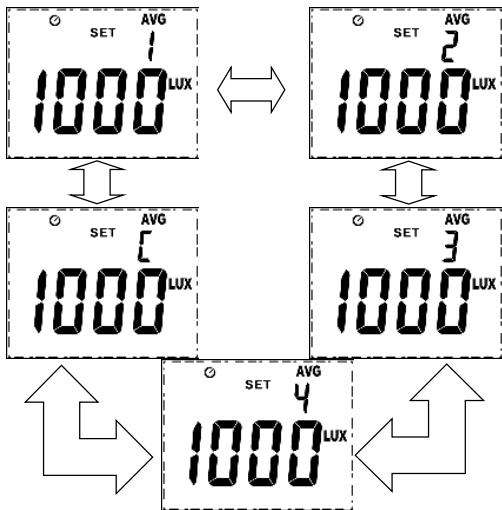

4. After the four points or the central point determined, press  button for 2 seconds to average the 4 or 5 points.

5. Press  button for 2 seconds to return to the mode of recording point setting.



OR



- ◇ Average of five points =  $(P1+P2+P3+P4+2PC)/6$ ;

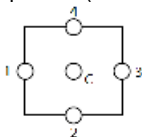

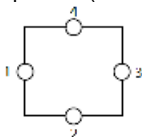

- ◇ Average of four points =  $(P1+P2+P3+P4)/4$



- ◇ Exiting the menu of 4-5 Point AVG, the value will return to zero.

### 5.13 Maximum and Minimum Hold



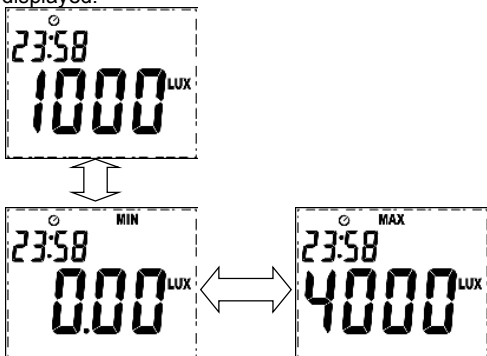

This function is designed to hold the maximum and minimum values displayed.

Press  button for 2 seconds to enter or exit the MAX/MIN menu while holding the present maximum or minimum value; then press  button for 1 second to switch the maximum and minimum values displayed.







### 5.14 Function Settings (Setup)

This function is for modifying the setting parameters of the meter





Press  button for 2 seconds to enter or exit the SETUP mode. As entering the SETUP mode, what the showing  button is for moving down,  button is for moving up,  button is for selection. Use the buttons to adjust the setting function described as the following steps 1 to 10.

## 1. Adjustment of Year:

Press  button to enter or exit the adjustment mode. When starting adjustment, the display will flash. Press  button for the adjustment of digits. Press  or  to adjust the number where the maximum is 9999.





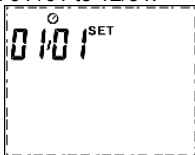

## 2. Adjustment of Month and Date:

Press  button to enter or exit the adjustment mode. When starting adjustment, the display will flash. Press  button for the adjustment of digits. Press  or  to adjust the number with the range from 01 /01 to 12/31.





## 3. Adjustment of Hour and Minute:

Press  button to enter or exit the adjustment mode. When starting adjustment, the display will flash. Press  button for the adjustment of digits. Press  or  to adjust the number with the range from 00:00 to 23:59.





## 4. Adjustment of Second:

Press  button to enter or exit the adjustment mode. When starting adjustment, the display will flash. Press  or  to adjust the number with the range from 00 to 59.







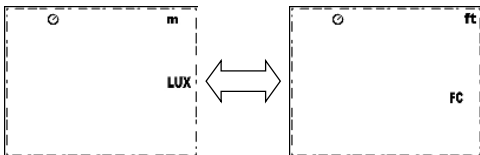

## 5. Unit setting:

Press  button to enter or exit the adjustment mode. When starting adjustment, the display will flash. Press  or  to switch the units LUX & m or FC & ft.



## 6. CD distance setting:

Press  button to enter or exit the adjustment mode. When starting adjustment, the display will flash. Press  button for the adjustment of digits. Press  or  to adjust the number with the range from 00.01 to 99.99m, where the initial setting is 1.00m.



✧  $CD = Lux \times r^2$



## 7. OFFSET settings:





The luminance output value can be adjusted. Press  button to enter or exit the adjustment mode. When starting adjustment, the display will flash.

Press  button for the adjustment of digits.

Press  or  to adjust the number with the range from 0.1% to 999.9%, where the initial setting is 100.0%.





## 8. Settings for switch the shifting mode from auto to fixed:

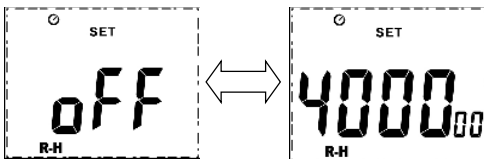

Press  button to enter or exit the adjustment mode while the symbol R-H will flash. Press  button to enable or to disable. Press  or  to adjust the shift with the selection of 400.0, 4000,

4000<sub>0</sub>, 4000<sub>00</sub>, where the initial setting is *off*.





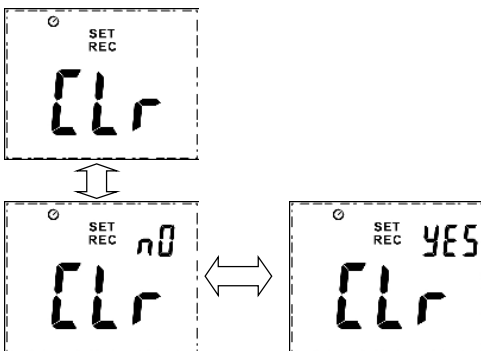

## 9. Clearing Record Manually:

Press  button, the symbol **no** located on the upper right corner of the display flashes, and repeatedly press  button to select **no** or **YES**.

When you select **YES** and press  button, the recorded data will be cleared manually, while the symbol **CLR** flashes once at the moment; if to select **no** and press  button, nothing will be cleared.



## 10. Reset:

Press  button the upper right corner of the display will start flashing, and press  button to select **no** or **YES**. When you select **YES** and press  button, the data will be reset and the meter will reboot; if to select **no** and press  button, nothing will be reset.

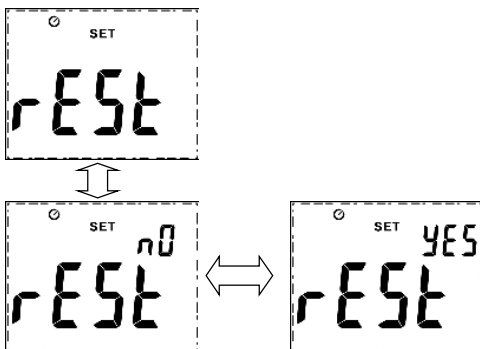

## 6 Software Installation

- Supported operating systems: Windows7/Windows 8.1/Windows10
- Place the CD included with this meter into the CD/DVD-ROM drive of the PC to connect to and install the desktop program:
- As the desktop application installed completely, remove the disc from the CD/DVD ROM drive.
- Connect the USB cable included with this meter to the PC, as shown in the figure below.

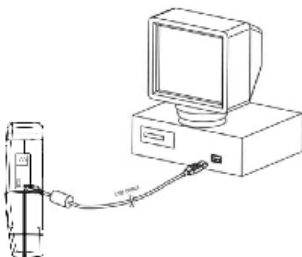

- Execute the PC desktop software program: Double-click the left mouse button on the desktop program to execute the desktop program.

## 7 General Specifications

- Display of reading: LCD display with 4 digits, where the maximum number shown is 9999.
- Unit: LUX /FC/CD
- Data holding function (HOLD)
- Automatic and manual shifting
- Backlight display
- Auto power off (15 minutes after last usage) and disable the function.
- Maximum/minimum hold.
- Overload indication: "OL".
- Datalogging capacity 7000 records.
- Interval of data storage: 1 second to 10 days.
- Low battery indication
- Average of 4 or 5 point
- Transmittance measurement
- Battery: 9V (NEDA 1604, IEC 6F22 or JIS 006P)
- Battery life: about 60 hours
- Standby power consumption: 90 $\mu$ W
- Operating power consumption: 90mW
- Operating temperature and humidity: 0°C to 50°C (32°F to 122°F ) relative humidity < 80%
- Storage temperature and humidity: -10°C to 60°C(10°F to 140°F ) , relative humidity < 80%
- Weight: about 300g
- Dimension:

Meter	140 (L) x 65 (W) x 37.5 (H) mm
Sensor	81 (L) x 57 (W) x 28 (H) mm

- Length of wiring for light sensor: Approx. 100 cm.

## 8 Electrical Specifications:

### 8.1 Quality Indices

Accuracy is specified for ambient temperatures between 15°C to 28°C (59°F to 82°F)

Standard	Comply with DIN 5032 Part7 Class C 、 JIS C 1609-1:2006 Class A 、 JJG 245-2005 Class B	
Test Range	400.0/4000/40,00 <sub>0</sub> /400,0 <sub>00</sub> Lux 40.00/400.0/4,000/40,00 <sub>0</sub> Foot-Candle	
Accuracy	0.1/1/10/100 Lux 0.01/0.1/1/10 Foot-Candle	
Relative spectral response (f1')	±8% CIE visible light V(λ)	
Cosine characteristic (f2)	±6%	
Oblique incident light characteristic	angle	10°: ±1.5%
		30°: ±3%
		60°: ±10%
		80°: ±30%
Accuracy	±3% (for light source A of 2856°K )	
Linearity (JISC 1609-1:2006) (Accuracy of various light sources)	< 3000 Lux :±5% with reading ± 1 3000 Lux to 9999 Lux:±7.5% with reading ± 1 > 10000Lux(930 FC) N/A	
Initial Adjustment (f <sub>ADJ</sub> ) DIN5032 Part7 JJG 245-2005	±5% with reading ± 1	
Linearity(f3) DIN5032 Part7 JJG 245-2005	±2.5%	
Range change(f11)	±2%	
Fatigue(f5)	-1%	

IR response( $f_{IR}$ )	$\pm 4\%$
UV response( $f_{UV}$ )	$\pm 2.5\%$
Temperature( $f_{6T}$ )	$\pm 1\%$
Response time	Auto shifting: $\leq 5$ seconds Manual shifting: $\leq 2$ seconds

## 8.2 Relative Visible Spectrum Response

Relative CIE 1931 standard spectral response

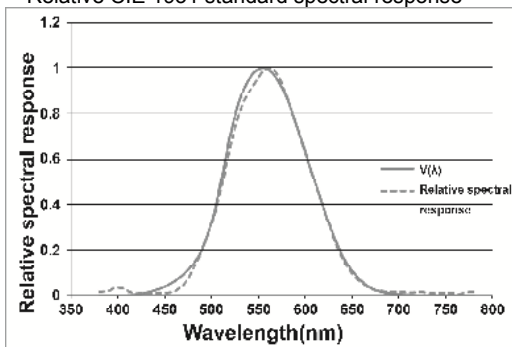



## 9 Maintenance or Repair

1. When the symbol “” appears on the LCD display, it indicates the battery low. Please replace the battery immediately to ensure accuracy.
2. If dirty, please wipe it with a soft cloth, such as glasses cloth, and not use a solvent such as chemicals.
3. If not in use for a long time, remove the battery to prevent battery liquid from leaking that may corrode the internal components.
4. When the symbol “Lob” appears on the LCD display, it indicates the battery low. Please replace the battery immediately for normal operation.

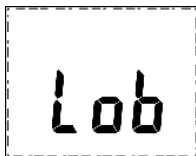

## 10 PRECAUTIONS

Removing Probe (With LOCK) :

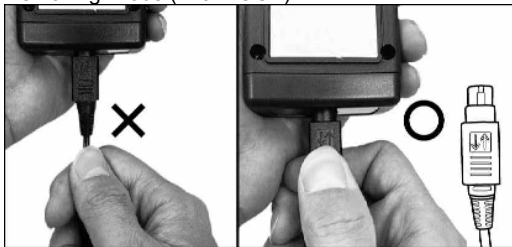

## 11 AC to DC Adaptor

External AC 100~240V to DC 9V/0.5A power supply

Plug: The pin in the center connects to the positive electrode and the outer case is negative electrode

Diameter: 5.5mm; internal diameter: 2.1mm

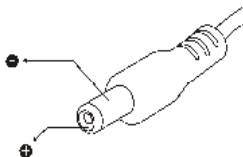

## 12 Replace the battery

1. Turn off the power.
2. Open the frame and battery cover at the back of the meter, remove the battery.
3. Install a new 9V battery. Please pay attention to the polarity positions of positive and negative.
4. Put the battery cover and frame back in place.

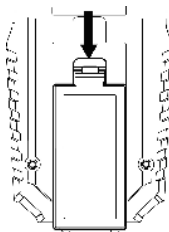

### **13 End of Life Disposal**



Note: This symbol indicates that the meter and its accessories must be separated and processed properly.

# TENMARS



## **Professional Electrical and Environment Test & Measurement Instruments:**

LED light meter, Temperature & Humidity meter, Infrared Thermometer, Sound level meter, Light meter, EMF meter, UV Light meter, RF meter, Hot wire Anemometer, Co meter, Anemometer, Lan cable tester, Co2 meter, Solar power meter, Radiation meter, Clamp meter, Multimeter, Phase Rotation test, Digital Insulation tester

**Our products of high quality are  
selling well all over the world**

**TENMARS ELECTRONICS CO., LTD.  
6F, NO.586 Ruiguang Rd, Neihu Dist.  
Taipei City, Taiwan  
E-mail: [service@tenmars.com](mailto:service@tenmars.com)  
<http://www.tenmars.com>**